

RS-RQ

Ø 32 ÷ 100 mm - **STRONG Compact Cylinders**
centering diameters, interaxes and piston rods complying with ISO 15552

Available ATEX version upon request
 II 2Gc IIC T5 II 2Dc T100°C



TECHNICAL CHARACTERISTICS

Ambient temperature	-20 ÷ 80°C
Fluid	filtered air, with or without lubrication
Working pressure	1,5 ÷ 10 bar
Bores	Ø 32 - 40 - 50 - 63 - 80 - 100 mm
Cushionings	adjustable pneumatic on both sides (UNIVER Original standard supplied)

CONSTRUCTIVE CHARACTERISTICS

End-caps	die-cast aluminium
Barrel	anodized aluminium
Piston	aluminium
Guide slide	acetalic resin
Piston rod	chromium-plated steel, stainless steel upon request
Piston seal	nitrile rubber (NBR)
Guide bush for piston rod	acetalic resin
Shock absorber seals	nitrile rubber (NBR) on both sides
Magnet	plasto-ferrite (standard supplied)

CODIFICATION KEY

R	S	2	0	0	0	3	2	0	0	2	5		
1	2	3	4				5			6	7		

1 Series	2 Type	3 Version	
RS Ø 32÷100 mm - STRONG Compact Cylinders	RS 1 = Stainless steel female piston rod 2 = Chromium-plated steel female piston rod 3 = Stainless steel male piston rod 4 = Chromium-plated steel male piston rod	Type 1 - 2 RS 00 = D.A. Standard version 01 = D.A. Through piston rod 10 = D.A. Non-rotating guided piston rod (Ø32÷63) 11 = D.A. Non-rotating guided through piston rod (Ø32÷63) 20 = D.A. Long piston (Ø32÷63) 60 = S.A. Retracted piston rod 70 = S.A. Extended piston rod	Type 3 - 4 RS 00 = D.A. Standard version 01 = D.A. Through piston rod 20 = D.A. Long piston (Ø32÷63) 60 = S.A. Retracted piston rod 70 = S.A. Extended piston rod
RQ Ø 32÷63 mm - STRONG Compact Cylinders Octagonal tube NON-ROTATING	RQ 1 = Stainless steel female piston rod with flange 2 = Chromium-plated steel female piston rod with flange	Type 1 - 2 RQ 00 = D.A. Standard version 01 = D.A. Through piston rod 20 = D.A. Long piston D.A. = Double acting S.A. = Single acting	

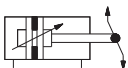

4 Bore (mm)	5 Stroke (mm)	6 Option	7 ATEX option
032 = Ø32 040 = Ø40 050 = Ø50 063 = Ø63 080 = Ø80 (only RS) 100 = Ø100 (only RS)	Single acting 0005 - 0010 - 0015 0020 - 0025 Double acting 0005 - 0010 - 0015 0020 - 0025 - 0030 0040 - 0050 - 0060 - 0080 Max standard stroke 0080 (Ø32÷100)	Max stroke with long piston (upon request) 0800 (Ø32-40) 1000 (Ø50-63) Max stroke with non-rotating guided piston rod (upon request) 0400 (Ø32-40) 0800 (Ø63) 0500 (Ø50)	X = ATEX (upon request) See ATEX Catalogue for types and versions
		C = With flange for RP series, version: 200-201-260-270 and 100-101-160-170 H = Hollow piston rod only for through piston rod versions without flange G = Preset for locking unit only for D.A. cylinders with chromium-plated steel piston rod	

Subject to change

Stroke tolerances

Maximum torque (Nm)
RQ

Ø	mm	Nm
32	+ 2-0	2
40	+ 2-0	3
50	+ 2-0	5
63	+ 2,5-0	8
80	+ 4-0	-
100	+ 4-0	-

Theoretical forces (N)
at different working pressure (bar)

Ø	Surface area		Working pressure					Working pressure				
	mm ²		bar					bar				
	Thrust	Traction	Thrust					Traction				
			2	4	6	8	10	2	4	6	8	10
32	804	691	161	322	482	643	804	138	276	414	553	691
40	1256	1056	251	502	754	1005	1256	211	422	633	844	1055
50	1962	1649	393	785	1178	1570	1963	330	660	990	1320	1650
63	3116	2802	623	1246	1869	2493	3116	560	1120	1680	2240	2800
80	5024	4533	1005	2010	3014	4019	5024	907	1814	2722	3629	4536
100	7850	7359	1570	3114	4710	6280	7850	1472	2944	4416	5888	7360

Graph of the theoretical thrust forces based on pressure and allowable strokes depending on maximum peak load

Peak load

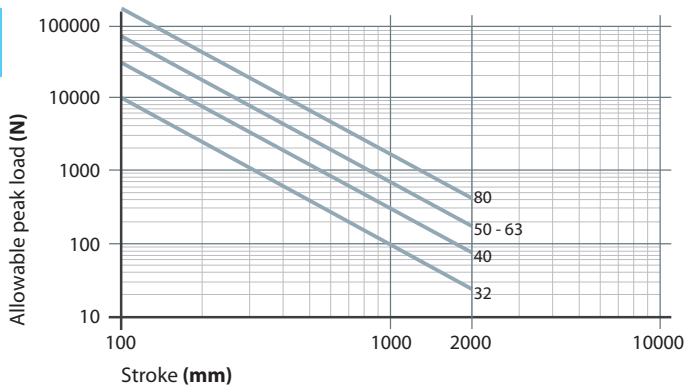

Theoretical forces of spring traction
for single-acting cylinder

Ø	Max force	Min. force	Max stroke	Decrease per mm stroke
	N	N	mm	N/mm
32	40	24	25	0,64
40	50	35	25	0,6
50	90	49	25	1,64
63	90	49	25	1,64
80	120	60	25	2,4
100	160	92,5	25	2,4

Graph side load on piston rod

Standard piston Ø16 ÷ 100 mm

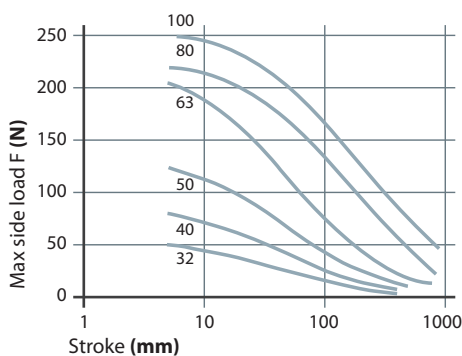

Extended piston Ø32 ÷ 100 mm

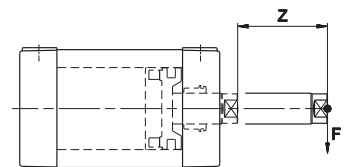
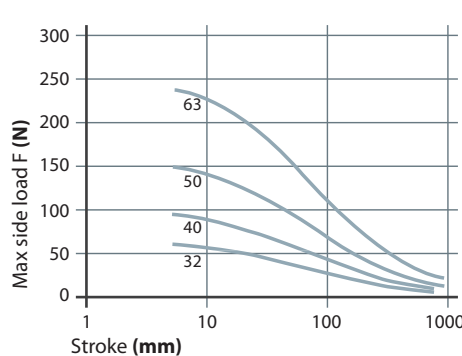

Z = Stroke
F = Force

Mass - standard cylinder **RS200/RS400**

Mass - long piston cylinder **RS220/RS420**

Ø	Cylinder stroke 0 Standard		Cylinder stroke 0 Long piston		Increase per mm stroke	Moving element stroke 0 Standard		Moving element stroke 0 Long piston		Increase per mm stroke
	g		g		g	g		g		g
	RS200	RS400	RS220	RS420	RS200/220 - RS400/420	RS200	RS400	RS220	RS420	RS200/220 - RS400/420
32	215	245	301,5	331,5	2,65	70	100	12,5	151,5	0,9
40	347	392	482	527	4	110	155	197	242	1,6
50	520	600	769	849	5,6	180	260	327	407	2,5
63	800	880	1151,5	1231,5	6,55	260	340	485	565	2,5
80	1204	1362	-	-	10,5	320	375	-	-	3,9
100	2079	2249	-	-	12,5	445	500	-	-	3,9

Mass - through piston rod cylinder **RS201/RS401**

Ø	Cylinder stroke 0		Increase per mm stroke	Moving element stroke 0		Increase per mm stroke
	g		g	g		g
	RS201	RS401	RS201 - RS401	RS201	RS401	RS201 - RS401
32	245	305	3,55	96	156	1,8
40	392	482	5,6	151	241	3,2
50	596	756	8,1	250	410	5
63	875	1035	9,05	330	490	5
80	1427	1747	14,5	350	430	7
100	2450	2761	16,5	405	470	9

Mass - retracted piston rod cylinder **RS260/RS460**

Mass - extended piston rod cylinder **RS270/RS470**

Ø	Cylinder stroke 0 Retracted piston rod		Cylinder stroke 0 Extended piston rod		Increase per mm stroke Retracted/Extended piston rod	Moving element - stroke 0 Retracted/Extended piston rod		Increase per mm stroke Retracted/Extended piston rod
	g		g		g	g		g
	RS260	RS460	RS270	RS470	RS260/RS460 - RS270/RS470	RS260/RS270	RS460/RS470	RS260/RS460 - RS270/RS470
32	217	247	213	243	2,65	73	103	0,9
40	350	395	344	398	4	116	161	1,6
50	525	605	515	595	5,6	192	272	2,5
63	805	885	795	875	6,55	272	352	2,5
80	1105	1261	1100	1102	10,5	350	430	3,9
100	2082	2128	1900	2002	12,5	420	480	3,9

Mass - non-rotating guided piston rod cylinder **RS210**

Mass - non-rotating guided through piston rod cylinder **RS211**

Ø	Cylinder stroke 0		Increase per mm stroke		Moving element stroke 0		Increase per mm stroke	
	g		g		g		g	
	RS210	RS211	RS210	RS211	RS210	RS211	RS210	RS211
32	255	285	3,09	3,99	110	136	1,34	2,24
40	414	459	4,8	6,4	177	218	2,4	4
50	622	698	6,4	8,9	282	352	3,3	5,8
63	952	1025	7,79	10,29	412	482	3,7	6,24

Mass - non-rotating guided piston rod cylinder **RQ200** and long piston **RQ220**

Ø	Cylinder stroke 0 Standard		Cylinder stroke 0 Long piston		Increase per mm stroke	Moving element stroke 0 Standard		Moving element stroke 0 Long piston		Increase per mm stroke
	g		g		g	g		g		g
	RQ200	RQ220	RQ200	RQ220	RQ200/220	RQ200	RQ220	RQ200	RQ220	RQ200/220
32	240	326,5	2,65	94	146,5	0,9				
40	386	522	4	148,5	237	1,6				
50	587	839	5,6	247	397	2,5				
63	894	1249,5	6,55	354	583	2,5				

Mass - non rotating guided through piston rod cylinder **RQ201**

Ø	Cylinder stroke 0		Increase per mm stroke	Moving element stroke 0		Increase per mm stroke
	g		g	g		g
	RQ201	RQ201	RQ201	RQ201	RQ201	
32	270	3,55	120	1,8		
40	431	5,6	189,5	3,2		
50	663	8,1	317	5		
63	969	9,05	424	5		

RS fixing elements and accessories

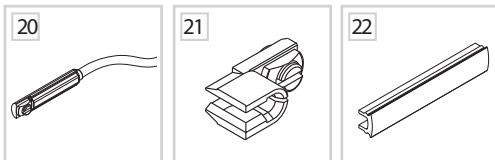
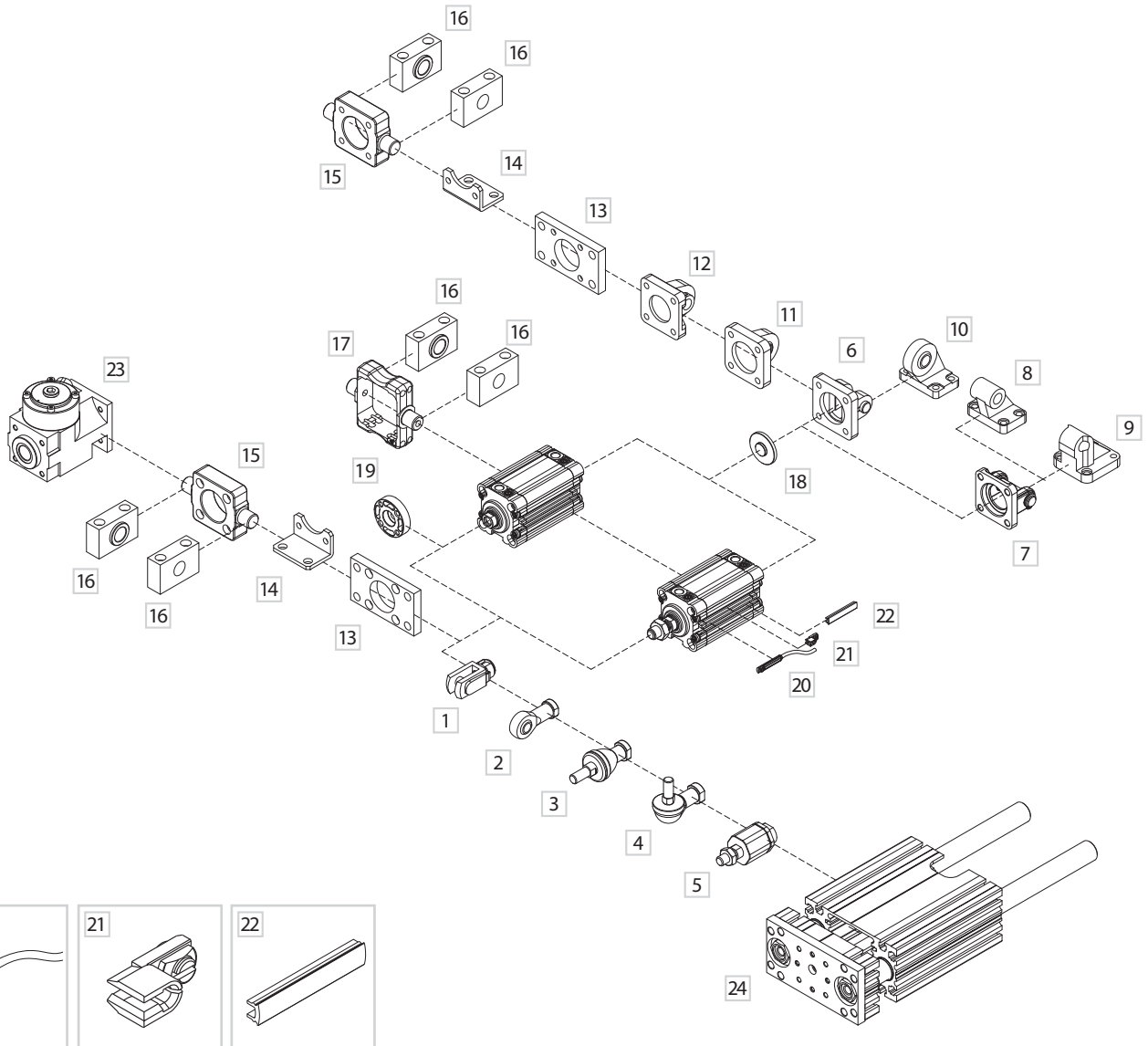

DESCRIPTION	PART NO.
1 Female fork with clips	KF-15 ___
2 Articulated self-lubricating fork	KF-17 ___
3 Fork with axially mounted articulated pin	KF-22 ___
4 Fork with angle mounted articulated pin	KF-23 ___
5 Floating joint	KF-24 ___
6 Female rear hinge with pin	KF-10 __A
7 Narrow female hinge with pin	KF-10 __AS
8 Counter hinge 90° (CETOP)	KF-19 __CTA
9 Counter hinge 90°	KF-19 ___
10 Articulated counter hinge	KF-19 __SC
11 Articulated rear male hinge	KF-11 __S
12 Rear male hinge	KF-11 ___
13 Front/rear flange	KF-12 ___
14 Angle bracket	KF-13 ___
15 Front/rear hinge with floating pin	KF-14 __AP
16 Hinge support	KF-41 ___
17 ISO intermediate hinge	KDF-14 ___ (Ø32-80-100)/ RPF-14 ___
18 Centering adaptor ring	RSF-09 ___
19 Flange for female piston rod	RPF-28 ___
20 DF Sensor (see accessories section)	DF-___
21 Cable clamping for DF sensor (see accessories section)	DF-001
22 DHF covering strip (see accessories section)	DHF-0020100
23 Locking unit	L1-N ___
24 Slide Units for pneumatic cylinders	J64RS

RQ fixing elements and accessories

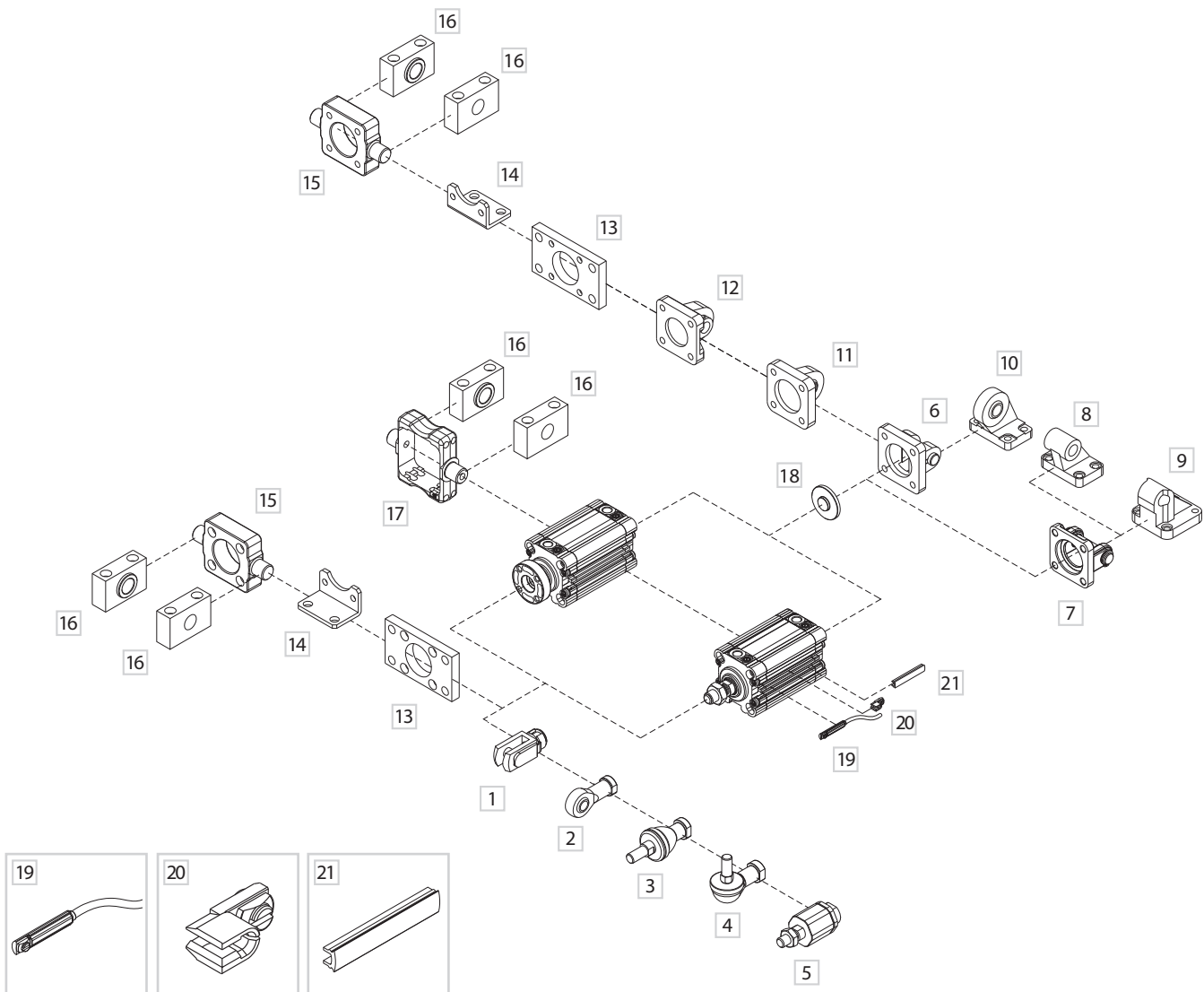

DESCRIPTION	PART NO.
1 Female fork with clips	KF-15___
2 Articulated self-lubricating fork	KF-17___
3 Fork with axially mounted articulated pin	KF-22___
4 Fork with angle mounted articulated pin	KF-23___
5 Floating joint	KF-24___
6 Female rear hinge with pin	KF-10___A
7 Narrow female hinge with pin	KF-10___AS
8 Counter hinge 90° (CETOP)	KF-19___CTA
9 Counter hinge 90°	KF-19___
10 Articulated counter hinge	KF-19___SC
11 Articulated rear male hinge	KF-11___S
12 Rear male hinge	KF-11___
13 Front/rear flange	KF-12___
14 Angle bracket	KF-13___
15 Front/rear hinge with floating pin	KF-14___AP
16 Hinge support	KF-41___
17 ISO intermediate hinge	KDF-14___ (Ø32-80-100)/ RPF-14___
18 Centering adaptor ring	RSF-09___
19 DF Sensor (see accessories section)	DF-___
20 Cable clamping for DF sensor (see accessories section)	DF-001
21 DHF covering strip (see accessories section)	DHF-0020100

Double acting standard RS Ø 32 ÷ 63

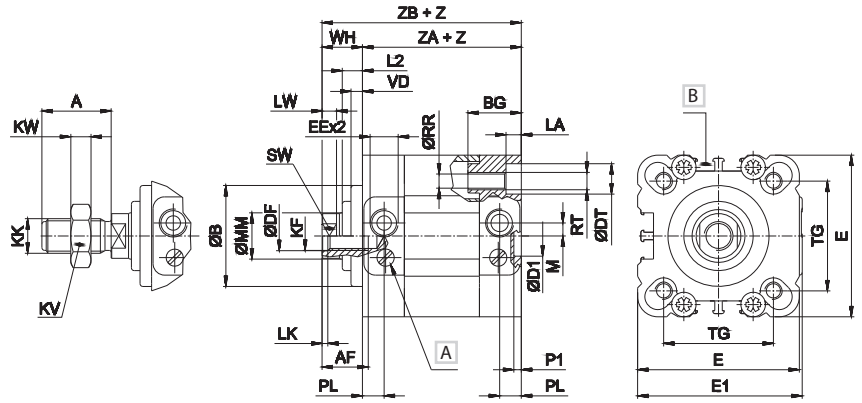
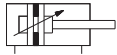
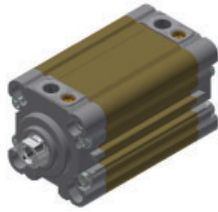

Double acting standard RS Ø 80 - 100

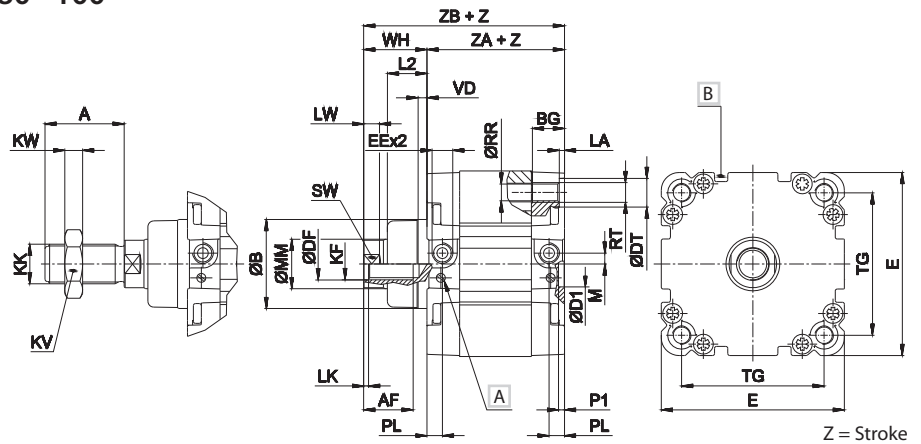
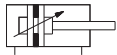

Ø	A	AF	B	BG	DF	DT	D1	E	EE	E1	KF	KK	KV	KW	LA
32	22	12	30	18	8,2	9	14	46	G1/8	47	M8	M10x1,25	17	6	5,3
40	24	16	35	18	10,2	9	14	56	G1/8	57	M10	M12x1,25	19	6	5,3
50	32	20	40	24	12,2	11	18	66	G1/8	67	M12	M16x1,5	24	7	6,5
63	32	20	45	24	12,2	11	18	79	G1/8	80	M12	M16x1,5	24	7	6,5
80	40	25	45	16,5	16,2	14	23	93,5	G1/8	-	M16	M20x1,5	30	9	2,6
100	40	25	55	21,5	16,2	14	28	112	G1/8	-	M16	M20x1,5	30	9	2,6

Ø	LK	LW	L2	M	MM	PL	P1	RR	RT	SW	TG	VD	WH	ZA	ZB
32	2	5	7	4,5	12	7,5	2,5	5,2	M6	10	32,5	4	14	44	58
40	2	5	7	4,5	16	7,5	2,5	5,2	M6	13	38	4	14	45	59
50	2	6	10	6,5	20	7,5	2,5	6,5	M8	17	46,5	5	18	45	63
63	2	6	10	6,5	20	7,5	2,5	6,5	M8	17	56,5	5	18	50	68
80	2,5	8	20	5,5	25	8	3	8,4	M10	22	72	4	32	54	86
100	2,5	8	20	8	25	10,5	3	8,4	M10	22	89	4	32	67	99

- A Pneumatic cushioning adjusting screw
- B Groove for sensor

Long piston RS Ø 32 ÷ 63

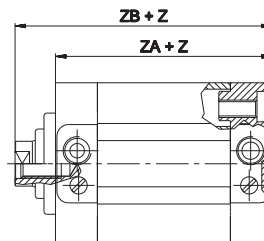

Z = Stroke

Ø	ZA	ZB
32	64	78
40	65	79
50	70	88
63	75	93

For cylinder types with long piston, dimensions ZA and ZB will be increased by 20 mm (Ø32 - Ø40 mm) and by 25 mm (Ø50 - Ø63 mm)

Double acting through piston rod RS Ø 32 ÷ 63

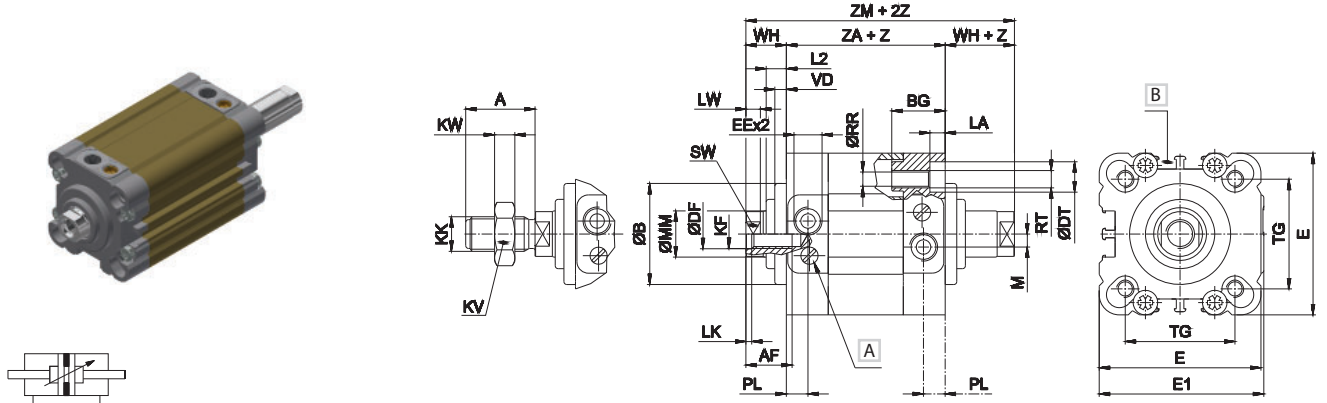

Double acting through piston rod RS Ø 80 - 100

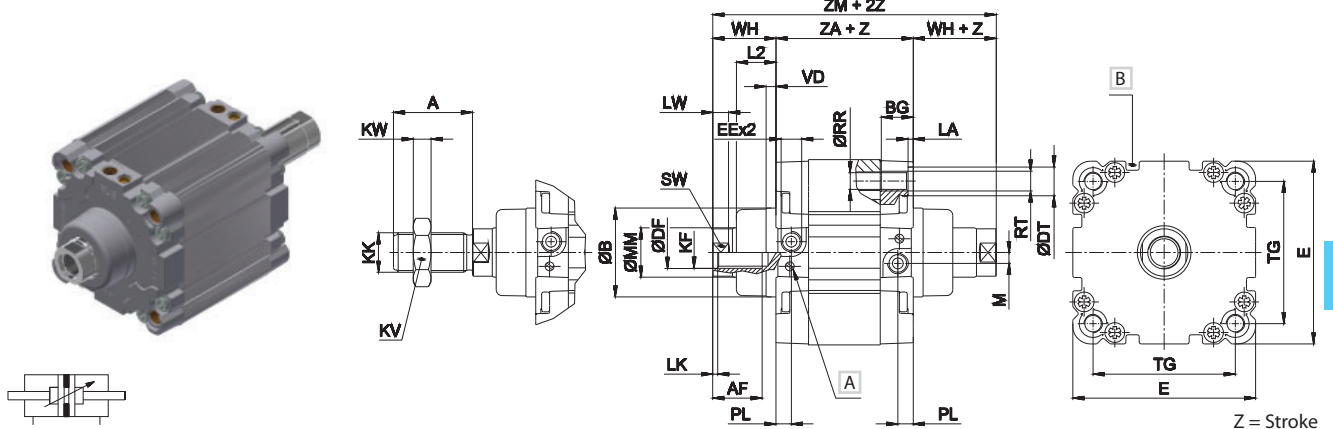

1
CYLINDERS

Ø	Dimensions (mm)														
	A	AF	B	BG	DF	DT	E	EE	E1	KF	KK	KV	KW	LA	
32	22	12	30	18	8,2	9	46	G1/8	47	M8	M10x1,25	17	6	5,3	
40	24	16	35	18	10,2	9	56	G1/8	57	M10	M12x1,25	19	6	5,3	
50	32	20	40	24	12,2	11	66	G1/8	67	M12	M16x1,5	24	7	6,5	
63	32	20	45	24	12,2	11	79	G1/8	80	M12	M16x1,5	24	7	6,5	
80	40	25	45	16,5	16,2	14	93,5	G1/8	-	M16	M20x1,5	30	9	2,6	
100	40	25	55	21,5	16,2	14	112	G1/8	-	M16	M20x1,5	30	9	2,6	

Ø	Dimensions (mm)														
	LK	LW	L2	M	MM	PL	RR	RT	SW	TG	VD	WH	ZA	ZM	
32	2	5	7	4,5	12	7,5	5,2	M6	10	32,5	4	14	44	72	
40	2	5	7	4,5	16	7,5	5,2	M6	13	38	4	14	45	73	
50	2	6	10	6,5	20	7,5	6,5	M8	17	46,5	5	18	45	81	
63	2	6	10	6,5	20	7,5	6,5	M8	17	56,5	5	18	50	86	
80	2,5	8	20	5,5	25	8	8,4	M10	22	72	4	32	54	118	
100	2,5	8	20	8	25	10,5	8,4	M10	22	89	4	32	67	131	

- A Pneumatic cushioning adjusting screw
- B Groove for sensor

Female/male hollow through piston rod RS Ø 32 ÷ 100

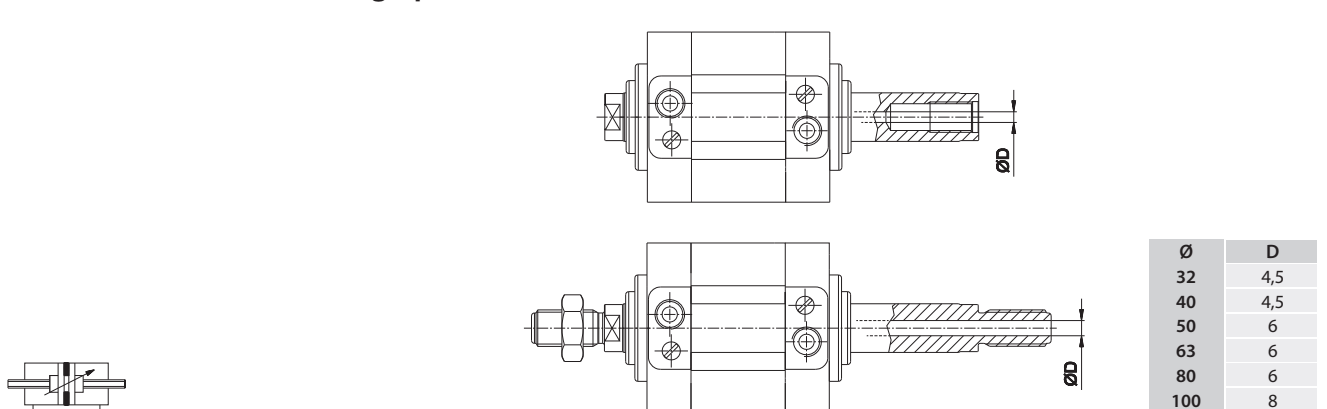

Ø16 ÷ 25 Max stroke **50 mm** Ø32 ÷ 63 Max stroke **75 mm** Ø80 - 100 Max stroke **100 mm**
 For all other dimensions please refer to the through piston rod version

Single acting retracted piston rod RS Ø 32 ÷ 63

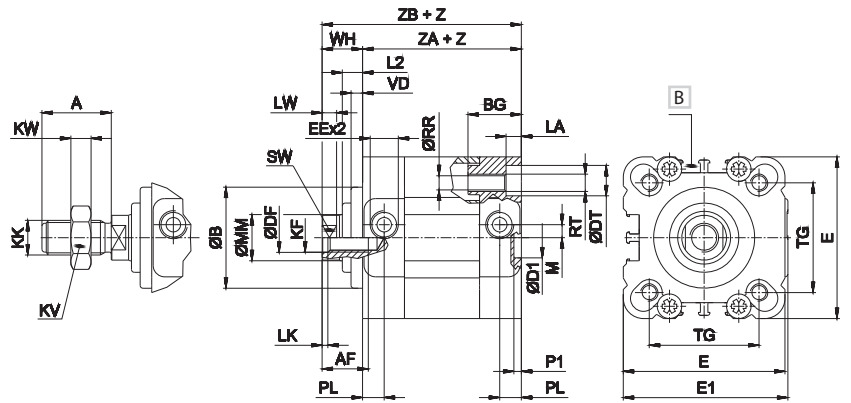
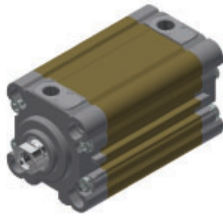

Single acting retracted piston rod RS Ø 80 - 100

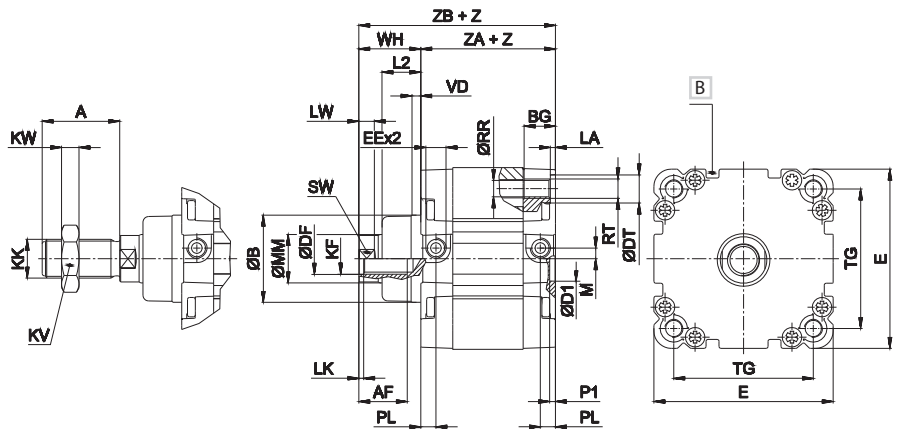

Z = Stroke

Ø	A	AF	B	BG	DF	DT	D1	E	EE	E1	KF	KK	KV	KW	LA
32	22	12	30	18	8,2	9	14	46	G1/8	47	M8	M10x1,25	17	6	5,3
40	24	16	35	18	10,2	9	14	56	G1/8	57	M10	M12x1,25	19	6	5,3
50	32	20	40	24	12,2	11	18	66	G1/8	67	M12	M16x1,5	24	7	6,5
63	32	20	45	24	12,2	11	18	79	G1/8	80	M12	M16x1,5	24	7	6,5
80	40	25	45	16,5	16,2	14	23	93,5	G1/8	-	M16	M20x1,5	30	9	2,6
100	40	25	55	21,5	16,2	14	28	112	G1/8	-	M16	M20x1,5	30	9	2,6

Ø	LK	LW	L2	M	MM	PL	P1	RR	RT	SW	TG	VD	WH	ZA	ZM
32	2	5	7	4,5	12	7,5	2,5	5,2	M6	10	32,5	4	14	44	58
40	2	5	7	4,5	16	7,5	2,5	5,2	M6	13	38	4	14	45	59
50	2	6	10	6,5	20	7,5	2,5	6,5	M8	17	46,5	5	18	45	63
63	2	6	10	6,5	20	7,5	2,5	6,5	M8	17	56,5	5	18	50	68
80	2,5	8	20	5,5	25	8	3	8,4	M10	22	72	4	32	54	86
100	2,5	8	20	8	25	10,5	3	8,4	M10	22	89	4	32	67	99

B Groove for sensor

Single acting extended piston rod RS Ø 32 ÷ 63

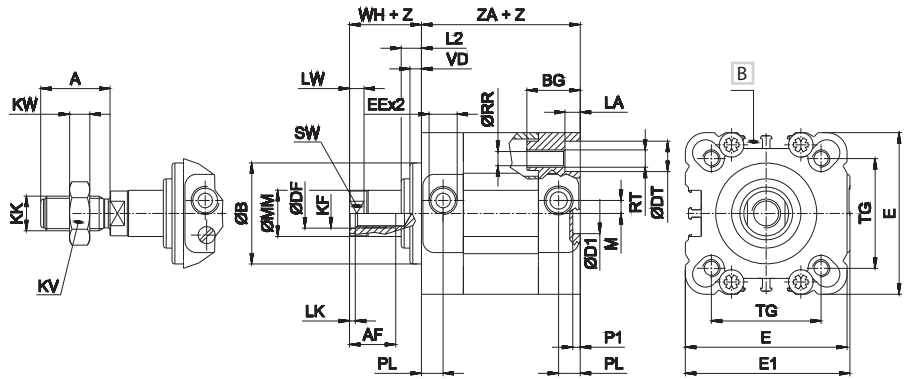
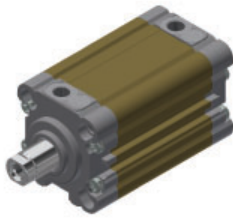

Single acting extended piston rod RS Ø 80 - 100

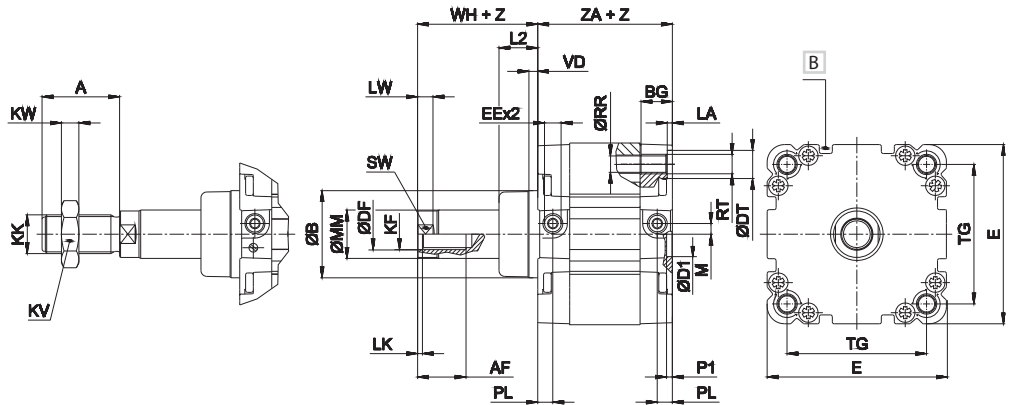
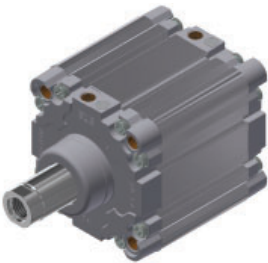

1
CYLINDERS

Z = Stroke

Ø	A	AF	B	BG	DF	DT	D1	E	EE	E1	KF	KK	KV	KW
32	22	12	30	18	8,2	9	H11	14	G1/8	47	M8	M10x1,25	17	6
40	24	16	35	18	10,2	9	14	56	G1/8	57	M10	M12x1,25	19	6
50	32	20	40	24	12,2	11	18	66	G1/8	67	M12	M16x1,5	24	7
63	32	20	45	24	12,2	11	18	79	G1/8	80	M12	M16x1,5	24	7
80	40	25	45	16,5	16,2	14	23	93,5	G1/8	-	M16	M20x1,5	30	9
100	40	25	55	21,5	16,2	14	28	112	G1/8	-	M16	M20x1,5	30	9

Ø	LA	LK	LW	L2	M	MM	PL	P1	RR	RT	SW	TG	VD	WH	ZA
32	5,3	2	5	7	4,5	12	7,5	2,5	5,2	M6	10	32,5	4	14	44
40	5,3	2	5	7	4,5	16	7,5	2,5	5,2	M6	13	38	4	14	45
50	6,5	2	6	10	6,5	20	7,5	2,5	6,5	M8	17	46,5	5	18	45
63	6,5	2	6	10	6,5	20	7,5	2,5	6,5	M8	17	56,5	5	18	50
80	2,6	2,5	8	20	5,5	25	8	3	8,4	M10	22	72	4	32	54
100	2,6	2,5	8	20	8	25	10,5	3	8,4	M10	22	89	4	32	67

B Groove for sensor

Double acting non-rotating guided piston rod RS Ø 32 ÷ 63

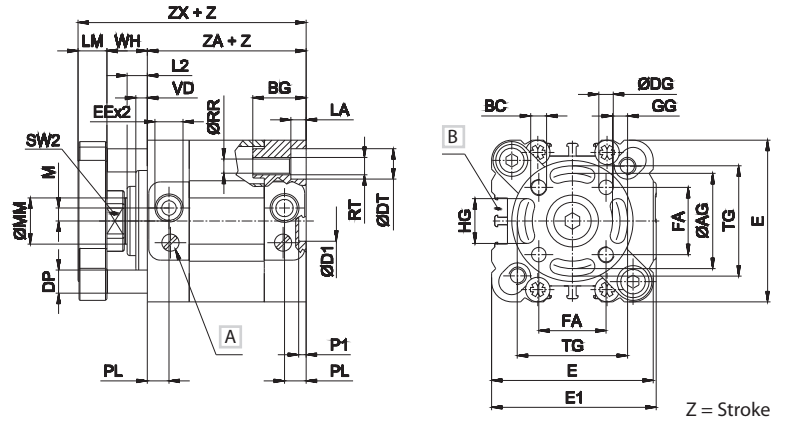
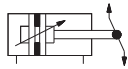

Ø	AG	BC	BG	DG	DP	DT	D1	E	EE	E1	FA	GG	HG	LA
32	28	M5	18	5	6	9	14	46	G1/8	47	19,8	5,2	11	5,3
40	33	M5	18	5	8	9	14	56	G1/8	57	23,3	5,2	15	5,3
50	42	M6	24	6	8	11	18	66	G1/8	67	29,7	6,2	19	6,5
63	50	M6	24	6	10	11	18	79	G1/8	80	35,4	6,2	25	6,5

Ø	LM	L2	M	MM	PL	P1	RR	RT	SW2	TG	VD	WH	ZA	ZX
32	10	7	4,5	12	7,5	2,5	5,2	M6	17	32,5	4	14	44	68
40	10	7	4,5	16	7,5	2,5	5,2	M6	19	38	4	14	45	69
50	12	10	6,5	20	7,5	2,5	6,5	M8	24	46,5	5	18	45	75
63	12	10	6,5	20	7,5	2,5	6,5	M8	24	56,5	5	18	50	80

A Pneumatic cushioning adjusting screw

B Groove for sensor

Double acting non-rotating guided through piston rod RS Ø 32 ÷ 63

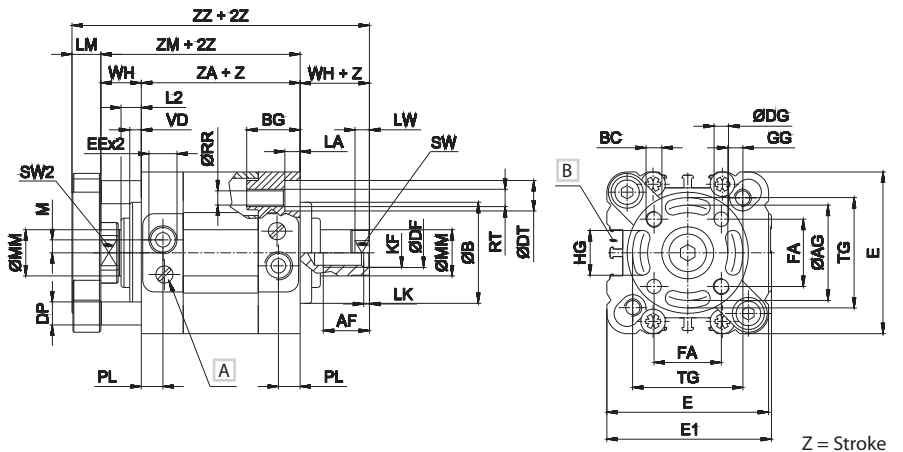
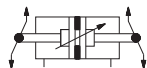

Ø	AF	AG	B	BC	BG	DF	DG	DP	D1	E	EE	E1	FA	GG	HG	KF	LA
32	12	28	30	M5	18	8,2	5	6	14	46	G1/8	47	19,8	5,2	11	M8	5,3
40	16	33	35	M5	18	10,2	5	8	14	56	G1/8	57	23,3	5,2	15	M10	5,3
50	20	42	40	M6	24	12,2	6	8	18	66	G1/8	67	29,7	6,2	19	M12	6,5
63	20	50	45	M6	24	12,2	6	10	18	79	G1/8	80	35,4	6,2	25	M12	6,5

Ø	LK	LM	LW	L2	M	MM	PL	RR	RT	SW	SW2	TG	VD	WH	ZA	ZM	ZZ
32	2	10	5	7	4,5	12	7,5	5,2	M6	10	17	32,5	4	14	44	72	82
40	2	10	5	7	4,5	16	7,5	5,2	M6	13	19	38	4	14	45	73	83
50	2	12	6	10	6,5	20	7,5	6,5	M8	17	24	46,5	5	18	45	81	93
63	2	12	6	10	6,5	20	7,5	6,5	M8	17	24	56,5	5	18	50	86	98

A Pneumatic cushioning adjusting screw

B Groove for sensor

Double acting standard RQ Ø 32 ÷ 63

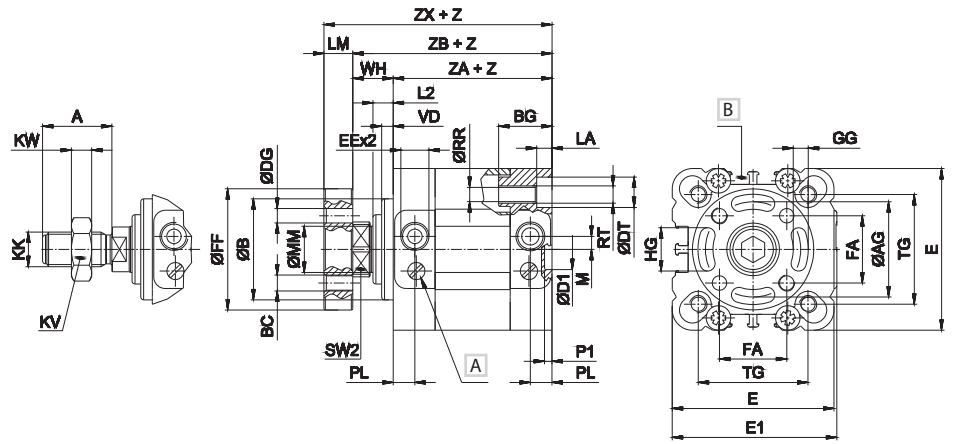
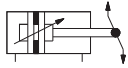
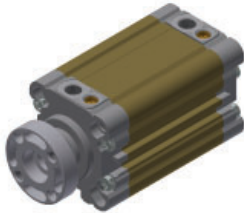

Z = Stroke

Ø	A	AG	B	BC	BG	DG	DT	D1	E	EE	E1	FA	FF	GG	HG	KK	KV	KW
32	22	28	30	M5	18	5	9	14	46	G1/8	47	19,8	37	5,2	11	M10x1,25	17	6
40	24	33	35	M5	18	5	9	14	56	G1/8	57	23,3	42	5,2	15	M12x1,25	19	6
50	32	42	40	M6	24	6	11	18	66	G1/8	67	29,7	52	6,2	19	M16x1,5	24	7
63	32	50	45	M6	24	6	11	18	79	G1/8	80	35,4	64	6,2	25	M16x1,5	24	7

Ø	LA	LM	LW	L2	M	MM	PL	P1	RR	RT	SW	SW2	TG	VD	WH	ZA	ZB	ZX
32	5,3	10	5	7	4,5	12	7,5	2,5	5,2	M6	10	17	32,5	4	14	44	58	68
40	5,3	10	5	7	4,5	16	7,5	2,5	5,2	M6	13	19	38	4	14	45	59	69
50	6,5	12	6	10	6,5	20	7,5	2,5	6,5	M8	17	24	46,5	5	18	45	63	75
63	6,5	12	6	10	6,5	20	7,5	2,5	6,5	M8	17	24	56,5	5	18	50	68	80

A Pneumatic cushioning adjusting screw

B Groove for sensor

Long piston RQ Ø 32 ÷ 63

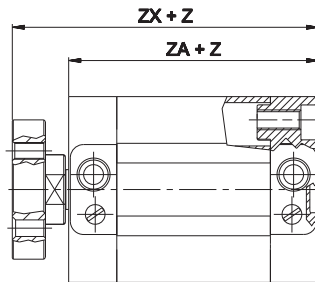

Z = Stroke

Ø	ZA	ZX
32	64	88
40	65	89
50	70	100
63	75	105

For cylinder types with long piston, dimensions ZA and ZB will be increased by 20 mm (Ø32 - Ø40 mm) and by 25 mm (Ø50 - Ø63 mm)

Double acting through piston rod RQ Ø 32 ÷ 63

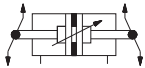
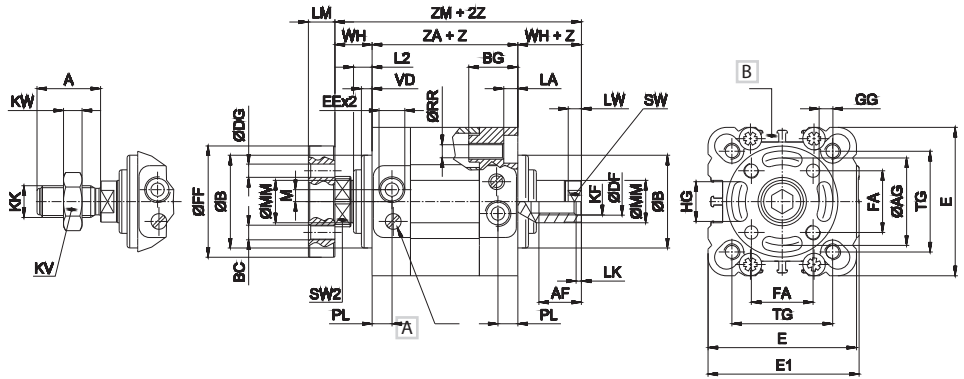
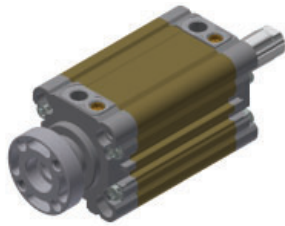

Ø	A	AF	AG	B	BC	BG	DF	DG	E	EE	E1	FA	FF	GG	HG	KF	KK
32	22	12	28	30	M5	18	8,2	5	46	G1/8	47	19,8	37	5,2	11	M8	M10x1,25
40	24	16	33	35	M5	18	10,2	5	56	G1/8	57	23,3	42	5,2	15	M10	M12x1,25
50	32	20	42	40	M6	24	12,2	6	66	G1/8	67	29,7	52	6,2	19	M12	M16x1,5
63	32	20	50	45	M6	24	12,2	6	79	G1/8	80	35,4	64	6,2	25	M12	M16x1,5

Ø	KV	KW	LA	LK	LM	LW	L2	M	MM	PL	RR	SW	SW2	TG	VD	WH	ZA	ZM
32	17	6	5,3	2	10	5	7	4,5	12	7,5	5,2	10	17	32,5	4	14	44	72
40	19	6	5,3	2	10	5	7	4,5	16	7,5	5,2	13	19	38	4	14	45	73
50	24	7	6,5	2	12	6	10	6,5	20	7,5	6,5	17	24	46,5	5	18	45	81
63	24	7	6,5	2	12	6	10	6,5	20	7,5	6,5	17	24	56,5	5	18	50	86

A Pneumatic cushioning adjusting screw

Z = Stroke

B Groove for sensor

Male hollow through piston rod RQ Ø 32 ÷ 63

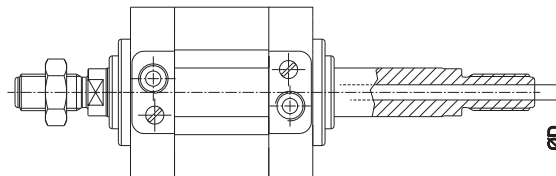

Ø	D
32	3,5
40	3,5
50	4,5
63	4,5

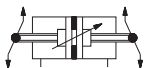

Ø16 ÷ 25 Max stroke **50 mm** Ø32 ÷ 63 Max stroke **75 mm**

For all other dimensions please refer to the through piston rod version

Female hollow through piston rod upon request

Tandem version

CODIFICATION KEY

R	S	2	A	0	3	2	0	8	0
1	2	3	4						

1 Series	2 Type	3 Bore (mm)	4 Stroke (mm)
RS = Ø 32÷100 mm - STRONG Compact Cylinders	1A = Double thrust tandem, stainless steel female piston rod (with flange for RQ series)	032 = Ø32 063 = Ø63	Upon request
RQ = Ø 32÷63 mm - STRONG Compact Cylinders Octagonal tube NON-ROTATING	2A = Double thrust tandem, chromium-plated steel female piston rod (with flange for RQ series)	040 = Ø40 080 = Ø80	
	3A = Double thrust tandem, stainless steel male piston rod	050 = Ø50 100 = Ø100	
	4A = Double thrust tandem, chromium-plated steel male piston rod		

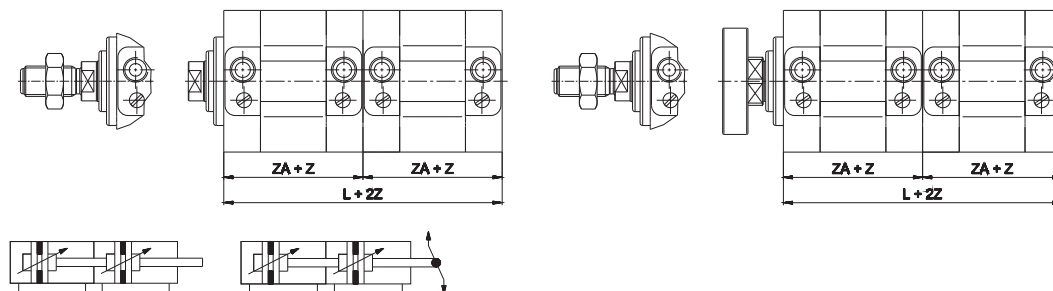

Ø	L	ZA
32	88	44
40	90	45
50	90	45
63	100	50
80	108	54
100	134	67

Tandem cylinders are constructed using two pistons coupled together which double the force in forward movement compared to the traditional cylinders of the same bore size

Two-position tandem version

CODIFICATION KEY

R	S	2	B	0	3	2	0	3	0	0	5	0
1	2	3	4	5								

1 Series	2 Type	3 Bore (mm)	4 Stroke Z1 (mm)	5 Stroke Z2 (mm)
RS = Ø 32÷100 mm - STRONG Compact Cylinders	1B = Two-position tandem, stainless steel female piston rod (with flange for RQ series)	032 = Ø32 063 = Ø63	Upon request	Upon request
RQ = Ø 32÷63 mm - STRONG Compact Cylinders Octagonal tube NON-ROTATING	2B = Two-position tandem, chromium-plated steel female piston rod (with flange for RQ series)	040 = Ø40 080 = Ø80		
	3B = Two-position tandem, stainless steel male piston rod	050 = Ø50 100 = Ø100		
	4B = Two-position tandem, chromium-plated steel male piston rod			

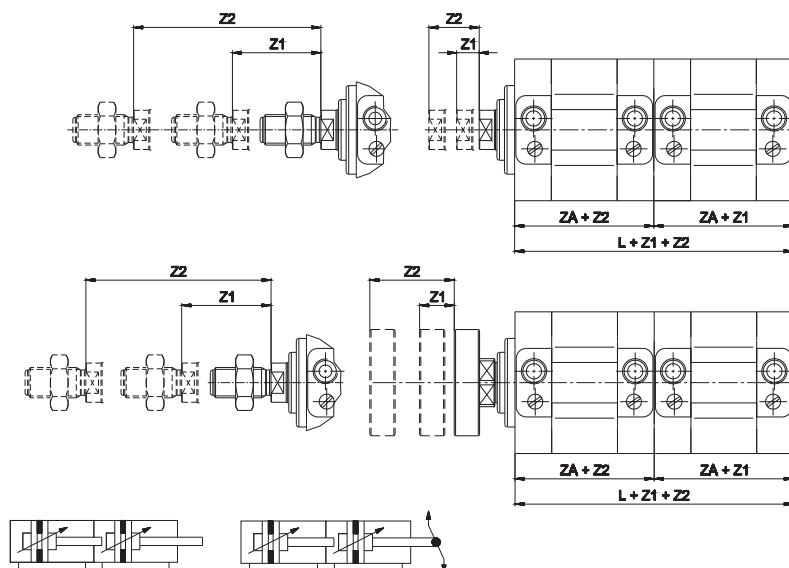

Z = Stroke

Ø	L	ZA
32	88	44
40	90	45
50	90	45
63	100	50
80	108	54
100	134	67

Two-position cylinders with two independent piston-rods which allow to realize a double positioning in which the thrust forces are the same as those of a cylinder of the same bore size

For all other dimensions please refer to the standard version
For other types of cylinders kindly contact our sales office

Subject to change

Opposed tandem version

CODIFICATION KEY

R	S	2	C	0	4	0	0	2	0	0	4	0
1		2		3				4			5	

1 Series	2 Type	3 Bore (mm)	4 Stroke Z1 (mm)	5 Stroke Z2 (mm)
RS = Ø 32÷100 mm - STRONG Compact Cylinders RQ = Ø 32÷63 mm - STRONG Compact Cylinders Octagonal tube NON-ROTATING	1C = Opposed tandem, stainless steel female piston rod (with flange for RQ series) 2C = Opposed tandem, chromium-plated steel female piston rod (with flange for RQ series) 3C = Opposed tandem, stainless steel male piston rod 4C = Opposed tandem, chromium-plated steel male piston rod	032 = Ø32 063 = Ø63 040 = Ø40 080 = Ø80 050 = Ø50 100 = Ø100	Upon request	Upon request

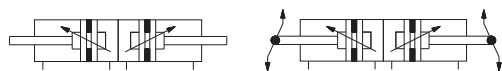
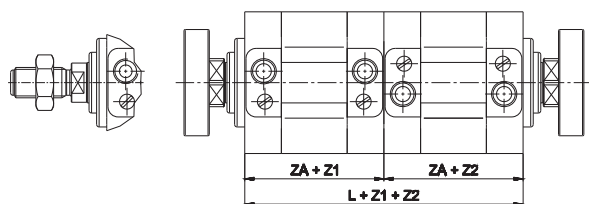
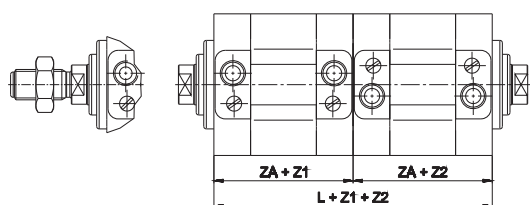

Type of cylinder characterized by the coupling of two cylinders piston rods move in opposite directions. The values of the thrust force are the same as those of the traditional cylinders

With common piston rod tandem version (upon request)

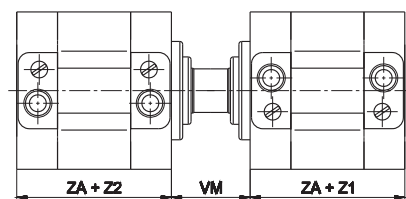

Type of cylinder characterized by the coupling of two cylinders and whose piston rods move in opposite directions. The values of the thrust force are the same as those of the traditional cylinders

Three-position version (upon request)

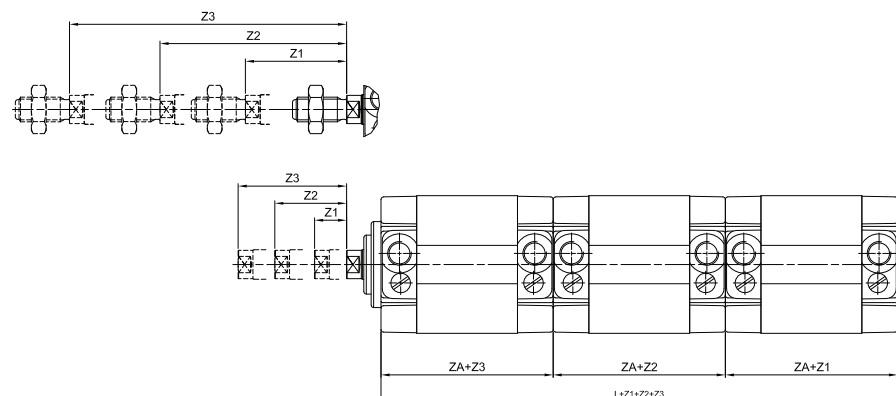

For all other dimensions please refer to the standard version
For other types of cylinders kindly contact our sales office

Z = Stroke

Ø	L	ZA
32	88	44
40	90	45
50	90	45
63	100	50
80	108	54
100	134	67

Z = Stroke

Ø	L	VM	ZA
32	88	14	44
40	90	14	45
50	90	16	45
63	100	16	50
80	108	20	54
100	134	20	67

Z = Stroke

Ø	L	ZA
32	132	44
40	135	45
50	135	45
63	150	50
80	162	54
100	201	67

Female rear hinge (ISO MP2) with pin

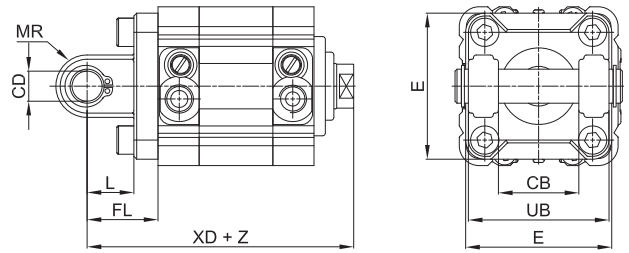
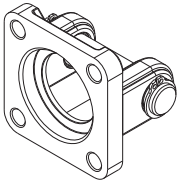

Material: Aluminium, zinc-plated steel pin

Z = Stroke

Cylinder Ø	CB	CD	E	FL	L	MR	UB	XD		Mass	Part no.
	H14	H9		± 0,2	min.	Max	h14			g	
32	26	10	48	22	12	11	45	80	±1,25	75	KF-10032A
40	28	12	54	25	15	13	52	84	±1,25	110	KF-10040A
50	32	12	65	27	15	13	60	90	±1,25	150	KF-10050A
63	40	16	75	32	20	17	70	100	±1,6	270	KF-10063A
80	50	16	95	36	20	17	90	103	±1,6	420	KF-10080A
100	60	20	115	41	25	21	110	118	±1,6	765	KF-10100A

By removing the pin it is possible to use the female hinge also on the front side

Narrow female hinge with pin (DIN 648K)

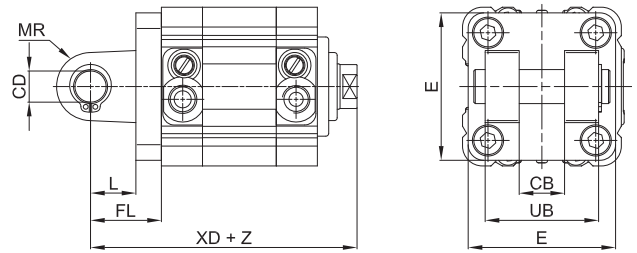
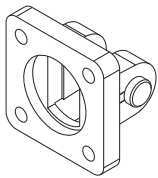

Material: Aluminium, zinc-plated steel pin

Z = Stroke

Cylinder Ø	CB	CD	E	FL	L	MR	UB	XD		Mass	Part no.
	H14	H9		± 0,2	min.	Max	h14			g	
32	14	10	45	22	13	10	34	73	±1,25	68	KF-10032AS
40	16	12	52	25	16	12	40	77	±1,25	112	KF-10040AS
50	21	16	65	27	16	14	45	80	±1,25	196	KF-10050AS
63	21	16	75	32	21	18	51	90	±1,6	288	KF-10063AS
80	25	20	95	36	22	20	65	100	±1,6	566	KF-10080AS
100	25	20	115	41	27	22	75	118	±1,6	818	KF-10100AS

Rear male hinge (ISO MP4)

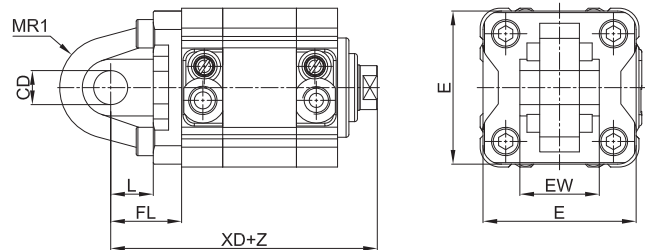
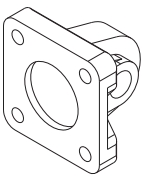

Material: Aluminium

Z = Stroke

Ø	CD	E	EW		FL	L	MR1	XD		Mass	Part no.
	h9		Nom.	Toll.	±0,2	min.				g	
32	10	48	26	-0,2 / -0,6	22	12	15*	80	±1,25	80	KF-11032
40	12	54	28	-0,2 / -0,6	25	15	18*	84	±1,25	100	KF-11040
50	12	65	32	-0,2 / -0,6	27	15	20*	90	±1,25	170	KF-11050
63	16	75	40	-0,2 / -0,6	32	20	23*	100	±1,6	250	KF-11063
80	16	95	50	-0,2 / -0,6	36	20	27*	103	±1,6	420	KF-11080
100	20	115	60	-0,2 / -0,6	41	25	29,5*	118	±2	660	KF-11100

* = Non-standard dimension

Articulated rear male hinge (ISO MP4)

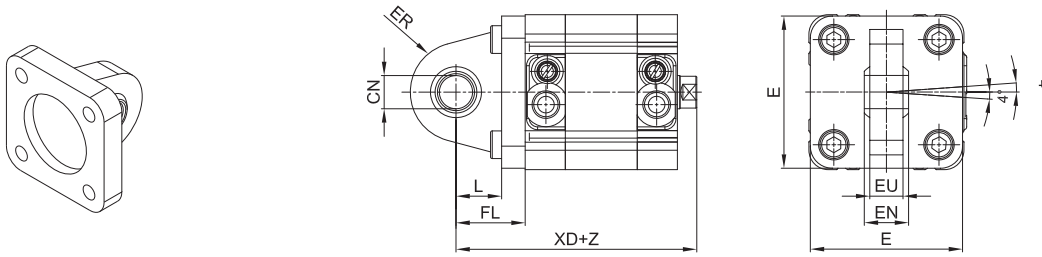

Material: Aluminium

Z = Stroke

Cylinder Ø	E	CN H9	ER	XD	L	EU	FL	EN	Mass g	Part no.
32	48	10	15	80	14	10,5	22	14	100	KF-11032S
40	54	12	18	84	16,5	12	25	16	200	KF-11040S
50	65	12	20	90	17,5	12	27	16	300	KF-11050S
63	75	16	21	99	21,5	15	32	21	350	KF-11063S
80	95	16	27	106	24	15	36	21	1600	KF-11080S
100	115	20	29,5	124	28	18	41	25	700	KF-11100S

Front/rear flange

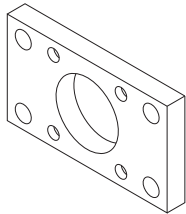

> Front assembly

> Rear assembly

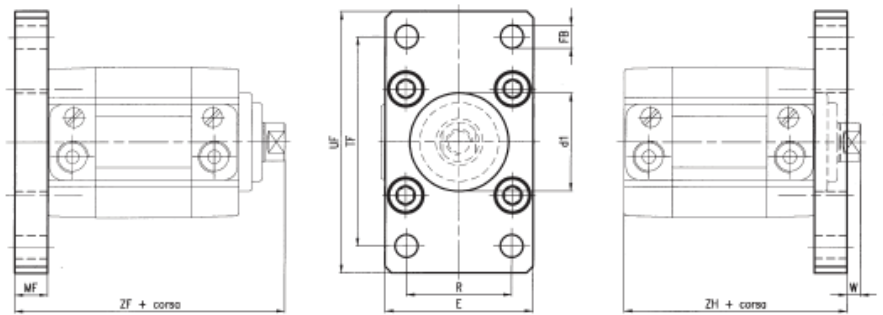

Material: Zinc-plated steel

Z = Stroke

Cylinder Ø	E	FB H13	W	MF ±0,2	R JS14	TF JS14	UF Max	ZF	ZH	Mass g	Part no.
32	45	7	4	10	32	64	80	68 ±1,25	54 ±1,25	200	KF-12032
40	52	9	4	10	36	72	90	69 ±1,25	55 ±1,25	250	KF-12040
50	65	9	6	12	45	90	110	75 ±1,25	57 ±1,25	500	KF-12050
63	75	9	6	12	50	100	120	80 ±1,6	62 ±1,6	650	KF-12063
80	95	12	16	16	63	126	150	102 ±1,6	70 ±1,6	1500	KF-12080
100	115	14	16	16	75	150	170	115 ±1,6	83 ±1,6	2200	KF-12100

VDMA standard upon request

Angle bracket

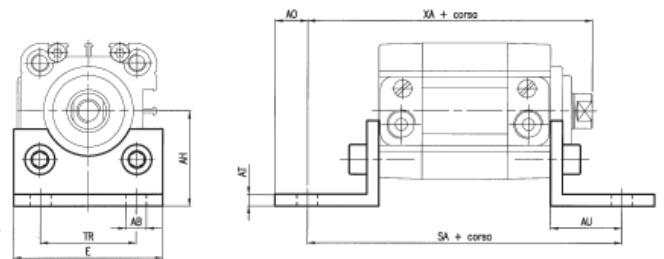
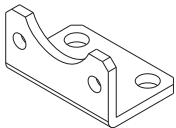

Material: Zinc-plated steel

Z = Stroke

Cylinder Ø	ØAB H13	AH JS15	AO	AT	AU ±0,2	E	SA	TR JS14	XA	Mass g	Part no.
32	7	32	6	4	24	45	92 Norm.	32	82 ±1,25	55	KF-13032
40	9 *	36	8	4	28	52	101 ±1,25	36	87 ±1,25	80	KF-13040
50	9 *	45	10	5	32	64	109 ±1,25	45	95 ±1,25	146	KF-13050
63	9 *	50	12	5	32	74	114 ±1,6	50	100 ±1,6	175	KF-13063
80	12	63	15	6	41	94	136 ±1,6	63	127 ±1,6	390	KF-13080
100	14 *	71	20	6	41	114	149 ±1,6	75	140 ±1,6	525	KF-13100

* = Non-standard dimension

ISO intermediate hinge

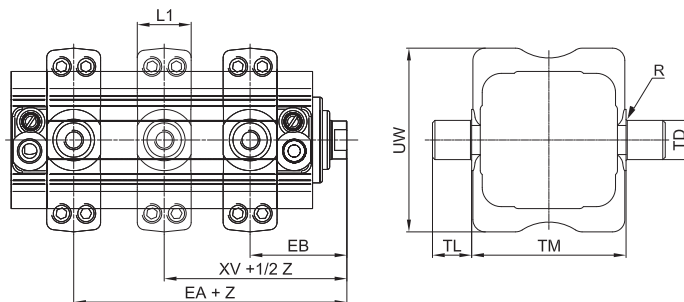
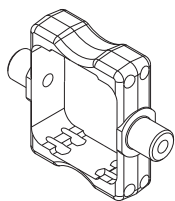

Material: Zinc-plated steel

Z = Stroke

Cylinder Ø	EA	EB	L1	R	TD	TL	TM	UW	XV		Mass g	Part no.
	Max	min.							e9	h14		
32	31	41	22	0,5	12	12	50	65	36	±2	120	KDF-14032
40	32	41	22	0,5	16	16	63	75	36,5	±2	240	RPF-14040
50	36	45	22	1	16	16	75	95	40,5	±2	320	RPF-14050
63	37	48	28	1	20	20	90	105	43	±2	470	RPF-14063
80	56,5	62,5	27,5	1	20	20	110	130	59	±2	800	KDF-14080
100	61	70	33	1	25	25	132	145	65,5	±2	1500	KDF-14100

The dimension XV + 1/2 indicates the position of the hinge between the end-caps of the cylinder

Front/rear hinge with floating pin

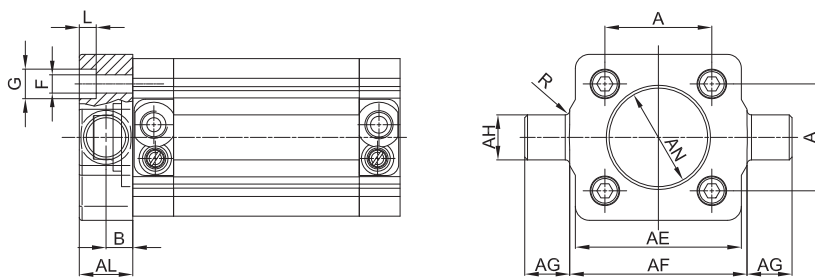
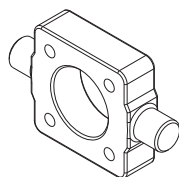

Material: Zinc-plated steel

Cylinder Ø	AE	AL	AH	AG	AF	AN	A	B	F	G	L	R	Mass g	Part no.
	Max	Max	e9	h14	h14	h11	±0,2	±0,2 / 0	h13	h13	±0,5 / 0	0 / ±0,3		
32	46	14	12	12	50	30	32,5	6,5	6,5	-	6	1	137	KF-14032AP
40	59	19	16	16	63	35	38	9	6,5	10,5	6	1,6	385	KF-14040AP
50	69	19	16	16	75	40	46,5	9	8,5	13,5	8	1,6	513	KF-14050AP
63	84	24	20	20	90	45	56,5	11,5	8,5	13,5	8	1,6	1041	KF-14063AP
80	102	24	20	20	110	45	72	11,5	10,5	16,5	10	1,6	1567	KF14080AP
100	125	29	25	25	132	55	89	14	10,5	16,5	10	2	3000	KF-14100AP

Counter hinge 90°

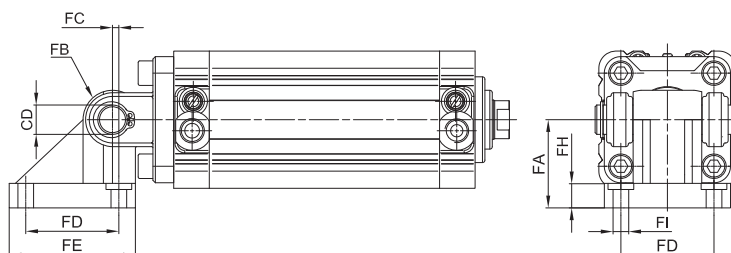
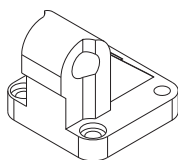

Material: Aluminium

Cylinder Ø	CD	FA	FB	FC	FD	FE	FG	FH	FI	F1	F2	Mass g	Part no.	
	H9													
32	10	32	10	1,2	32,5	46,5	26	-0,2 / -0,6	9	6,5	5,5	10,5	90	KF-19032
40	12	36	12	2,6	38	51,5	28	-0,2 / -0,6	9	6,5	5,5	10,5	120	KF-19040
50	12	45	12	0,3	46,5	63,5	32	-0,2 / -0,6	9	8,5	5	13,5	200	KF-19050
63	16	50	16	3,3	56,5	73,5	40	-0,2 / -0,6	10,5	8,5	5	13,5	320	KF-19063
80	16	63	16	1,0	72	93	50	-0,2 / -0,6	12	10,5	4,5	16,5	580	KF-19080
100	20	73	20	2,5	89	113	60	-0,2 / -0,6	13	10,5	4,5	16,5	910	KF-19100

Counter hinge 90° (CETOP)

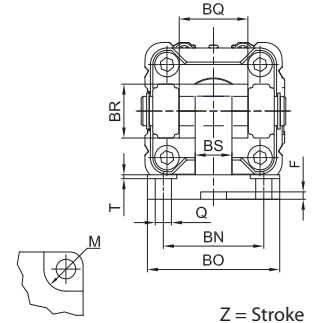
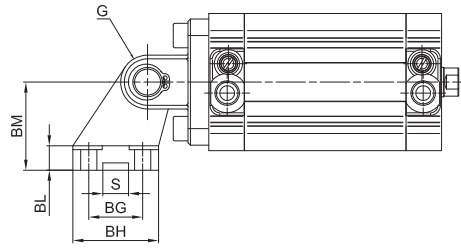
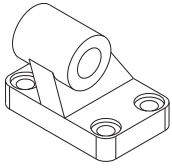

Z = Stroke

Material: Aluminium

Cylinder Ø	Q	M	BG	BH	BI	BL	BM	BN	BO	BS	BR	T	G	S	F	BQ	Mass g	Part no.	
	H13	H13	JS14	Max	JS14		Max	Max	Max	Max	Max	Max	H9	+0,5/0	+0,5/0				
32	6,6	11	18	31	21	8	32	38	51	10	20	1,6	10	10,5	3	26	-0,2 -0,6	56	KF-19032CTA
40	6,6	11	22	35	24	10	36	41	54	15	22	1,6	12	10,5	3	28		139	KF-19040CTA
50	9	15	30	45	33	12	45	50	65	16	26	1,6	12	10,5	3	32		142	KF-19050CTA
63	9	15	35	50	37	14	50	52	67	16	30	1,6	16	10,5	3	40		200	KF-19063CTA
80	11	18	40	60	47	14	63	66	86	20	30	2,5	16	10,5	3	50		321	KF-19080CTA
100	11	18	50	70	55	17	71	76	96	20	38	2,5	20	10,5	3	60	656	KT-19100CTA	

Counter hinge 90° (CNOMO)

1

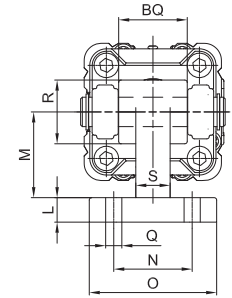
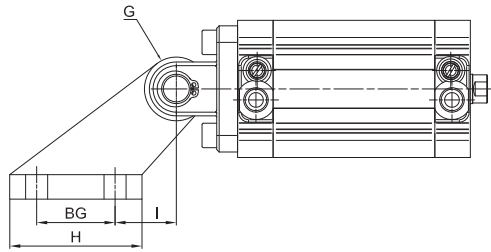
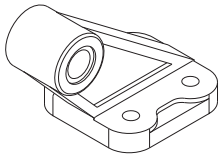

Z = Stroke

Material: Aluminium

Cylinder Ø	Q	BG	H	I	L	M	N	O	S	R	BQ	G	Mass g	Part no.
	H13	±0,2		±0,2		±0,2	±0,2			Max	±0,2/ ±0,1	H9		
32	7	20	37	18	8	32	25	41	9	19,5	25	8	58	KF-19032CN
40 - 50	9	32	54	25	10	45	32	52	14	26	32	12	144	KF-19040050CN
63 - 80	11	50	75	32	13	63	40	63	14	32	46	16	300	KF-19063080CN
100	14	70	103	40	17	90	50	80	22	42	56	20	694	KF-19100125CN

Articulated counter hinge

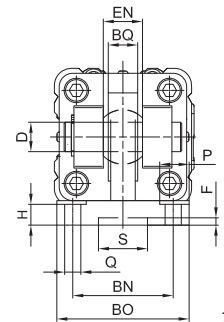
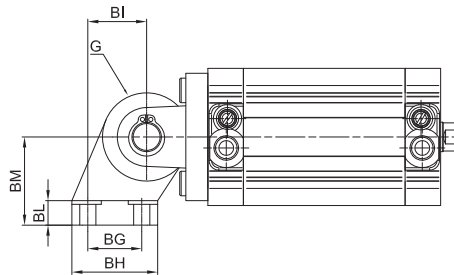
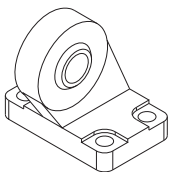

Z = Stroke

Material: Aluminium

Cylinder Ø	Q	P	BG	BH	BI	BL	BM	BN	BO	EN	ER	BQ	D	H	S	F	Mass g	Part no.
	H13	H13	JS14	Max														
32	6,6	11	18	31	21	10	32	38	51	14	15	10,5	10	8,5	20	3	178	KF-19032SC
40	6,6	11	22	35	24	10	36	41	54	16	18	12	12	8,5	20	3	268	KF-19040SC
50	9	15	30	45	33	12	45	50	65	21	20	15	16	10,5	20	3	458	KF-19050SC
63	9	15	35	50	37	12	50	52	67	21	23	15	16	10,5	20	3	550	KF-19063SC
80	11	18	40	60	47	14	63	66	86	25	27	18	20	11,5	20	3	970	KF-19080SC
100	11	18	50	70	55	15	71	76	96	25	30	18	20	12,5	20	3	1326	KF-19100SC

Hinge support

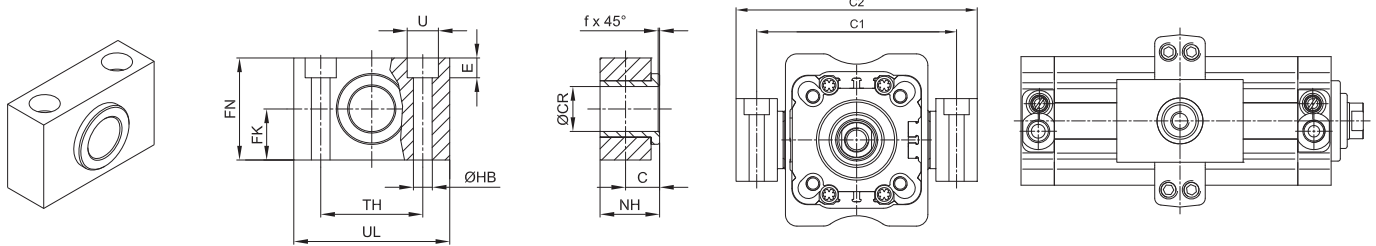

Material: Anodized aluminium and brass bushing

Z = Stroke

Ø	C	CR	FK	FN	HB	NH	TH	UL	U	E	F	C1	C2	Mass	Part no.		
		F7	± 0,1				± 0,1			± 0,5				g			
32	10,2	12	15	30	6,6	18	32	46	11	7	1	71	86	110	KF-41032		
40-50	12	16	18	36	9	21	36	55	15	9	1,6	Ø40	Ø50	200	KF-41040050		
												Ø63	Ø80			Ø63	Ø80
63-80	13	20	20	40	11	23	42	65	18	11	1,6	Ø100	Ø125	267	KF-41063080		
												Ø100	Ø125			Ø100	Ø125
100-125	16	25	25	50	14	28,5	50	75	20	13	2	164	192	189	217	485	KF-41100125

Centering adaptor ring

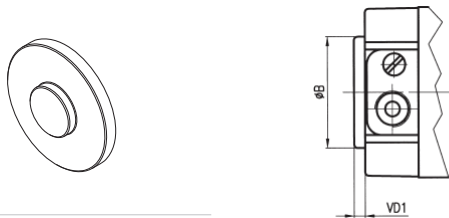

Material: Aluminium

Cylinder Ø	B	VD1	Part no.
32	30	3	RSF-09032
40	35	3	RSF-09040
50	40	3	RSF-09050
63	45	3	RSF-09063
80	45	4	RSF-09080
100	55	5	RSF-09100

Pin with 2 circlips

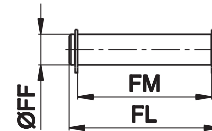

Cylinder Ø	FF	FL	FM	Mass	Part no.
	f8			g	
32	10	53	46	30	KF-18032
40	12	61,3	53	50	KF-18040
50	12	69	61	50	KF-18050
63	16	80,5	71	120	KF-18063
80	16	100,5	91	150	KF-18080
100	20	122,5	111	290	KF-18100

Pin for narrow hinge

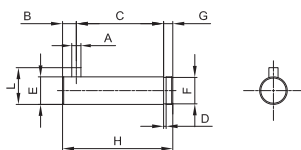

Material: Zinc-plated steel

Ø	A	C	D	E	F	G	H	L	B	Part no.
	H12	+0,5/ +0,3	H13	F7	H11			0 / -0,5		
32	3	32,5	1,1	10	9,6	4	41	14	4,5	KF-18032S
40	4	38	1,1	12	11,5	4	48	16	6	KF-18040S
50	4	43	1,1	16	15,2	5	54	20	6	KF-18050S
63	4	49	1,1	16	15,2	5	60	20	6	KF-18063S
80	4	63	1,3	20	19	6	75	24	6	KF-18080S
100	4	73	1,3	20	19	6	85	24	6	KF-1/8100S

> Fixing screws

Cylindrical screw
UNI 5931 suitable for
mounting elements
Series KF-12.../KF-13...

Cylinder Ø	Screw	Part no.
32 - 40	M6x20	AZ4-VN0620
50 - 63	M8x25	AZ4-VN0825
80 - 100	M10x30	AZ4-VN1030

Cylindrical screw
UNI 5931 suitable for
mounting elements
Series KF-10.../KF-11

Cylinder Ø	Screw	Part no.
32 - 40	M6x25	AZ4-VN0625
50 - 63	M8x30	AZ4-VN0830
80 - 100	M10x30	AZ4-VN1030

Cylindrical screw
UNI 5931 and DIN 7984 suitable for
mounting elements
Series KF-19...(Ø32-40-80-100)

Cylinder Ø	Screw	Part no.
32 - 40	M6x20 ^(a)	AZ4-VN0620
	M6x25 ^(b)	AZ4-VN0625
80 - 100	M10x30	AZ4-VN1030
	M10x30	AZ4-VN1030

Cylindrical screw
DIN 7984 suitable for
mounting elements
Series KF-19...(Ø50-63-80-100)

Cylinder Ø	Screw	Part no.
50 - 63	M8x25 ^(a)	AZ4-VPA0825
	M8x30 ^(b)	AZ4-VPA0830
80 - 100	M10x30	AZ4-VN1030
	M10x30	AZ4-VN1030

Female fork with clips

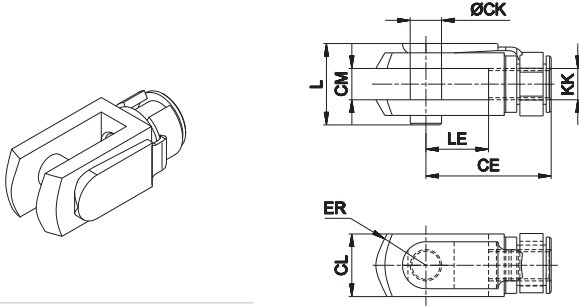

Material: Zinc-plated steel

Cylinder Ø	CE	CK	CL	CM	ER	KK	L	LE	Mass g	Part no.
32	40	10	20	10	16	M10x1,25	26	20	90	KF-15032
40	48	12	24	12	19	M12x1,25	32	24	150	KF-15040
50 - 63	64	16	32	16	25	M16x1,5	40	32	340	KF-15050
80 - 100	80	20	40	20	32	M20x1,5	50	40	670	KF-15080

Fork with pin suitable for piston rod according to ISO 8140 standard

Articulated self-lubricating fork

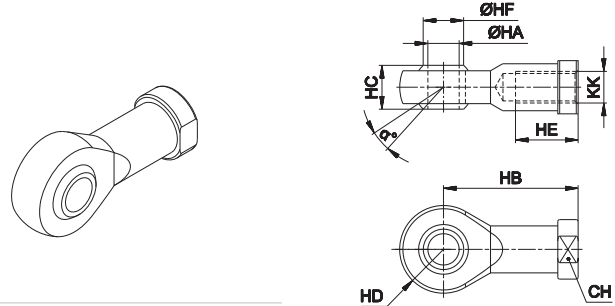

Material: Zinc-plated steel

Cylinder Ø	α°	CH	KK	HA	HB	HC	HD	HE	HF	Mass g	Part no.
32	13	17	M10x1,25	10	43	14	14	20	12,9	76	KF-17032
40	13	19	M12x1,25	12	50	16	16	22	15,4	110	KF-17040
50 - 63	15	22	M16x1,5	16	64	21	21	28	19,3	220	KF-17050
80 - 100	14	30	M20 x 1,5	20	77	25	25	33	24,3	400	KF-17080

Fork with axially mounted articulated pin

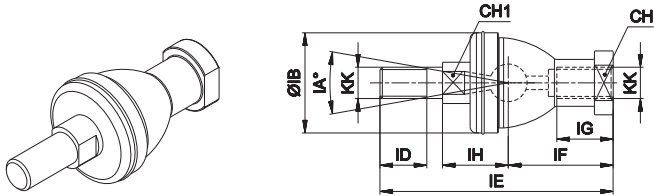

Material: Zinc-plated steel

Cylinder Ø	CH	CH1	IA°	KK	IH	IB	ID	IE	IF	IG	Mass g	Part no.
32	17	11	30	M10x1,25	19,5 ±0,3	32	15	74,5	35	18	120	KF-22025
40	19	17	30	M12x1,25	22	36	17	84	40	20	185	KF-22040
50 - 63	22	19	22	M16x1,5	27,5	47	23	112	50	27	360	KF-22050
80 - 100	30	24	15	M20x1,5	31,5	58	25	133	63	38	570	KF-22080

Fork with angle mounted articulated pin

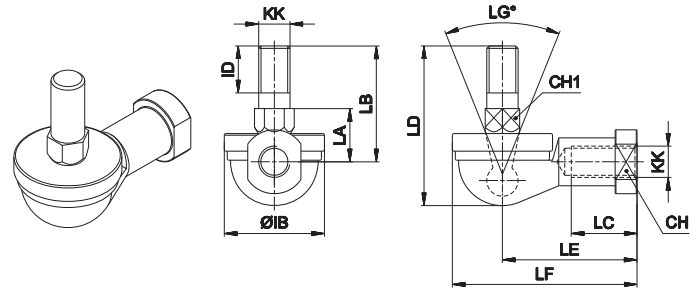

Material: Zinc-plated steel

Cylinder Ø	CH	CH1	LG°	KK	IB	ID	LA	LB	LC	LD	LE	LF	Mass g	Part no.
32	17	11	50	M10x1,25	32	15	17	37	21	50,5	43	57	110	KF-23025
40	19	17	50	M12x1,25	36	17	19	42	27	57,5	50	66	165	KF-23040
50 - 63	22	19	40	M16x1,5	47	23	23,5	60	33	79,5	64	84	330	KF-23050
80 - 100	30	24	32	M20x1,5	58	25	27	68	40	90	77	99	540	KF-23080

Floating joint

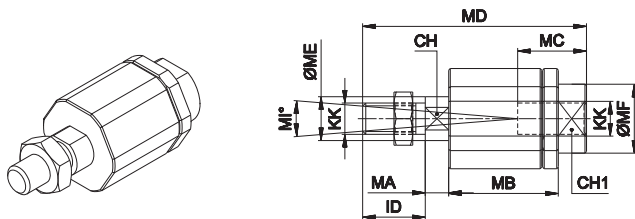

Material: Zinc-plated steel

Cylinder Ø	CH	CH1	ID	KK	MA	MB	MC	MD	ME	MF	MG	MH	MI°	Mass g	Part no.
32	12	19	71	M10x1,25	5	35	20	71	14	22	30	32	8	220	KF-24032
40	12	19	75	M12x1,25	5	35	20	75	14	22	30	32	8	230	KF-24040
50 - 63	20	30	103	M16x1,5	8	54	32	103	22	32	41	45	6	660	KF-24050
80 - 100	20	30	119	M20x1,5	8	54	40	119	22	32	41	45	6	700	KF-24080

Piston rod locknut (zinc-plated steel)

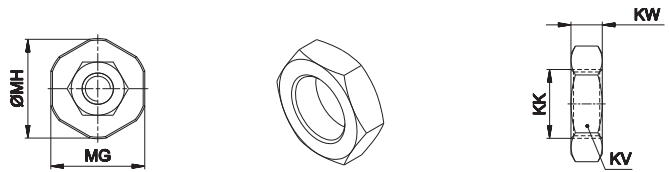

Material: Zinc-plated steel

Cylinder Ø	KK	KV	KW	Mass g	Part no.
32	M10x1,25	17	6	5	KF-16032
40	M12x1,25	19	7	10	KF-16040
50 - 63	M16x1,5	24	8	20	KF-16050
80 - 100	M20x1,5	30	9	30	KF-16080

Locking unit

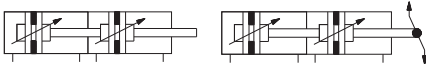
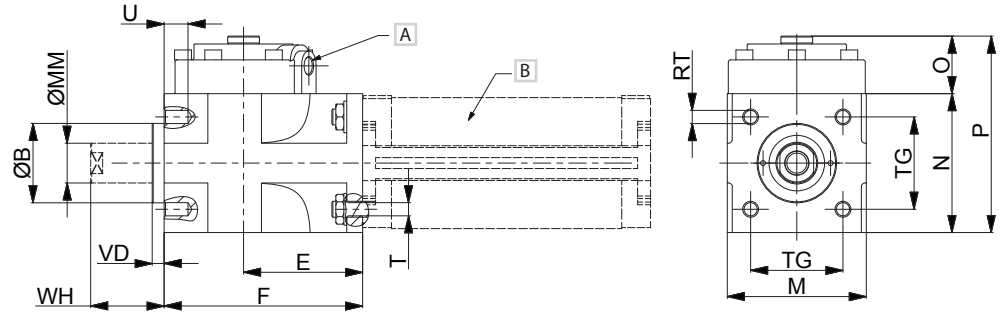

A G1/8 pneumatic release
B STRONG cylinder

Ø	B	RT	E	F	M	MM	N	O	P	TG	U	T	VD	WH
32	30	M6	54,5	84	50	12	50	29,5	79,5	32,5	10	6,5	6	26
40	35	M6	58	90	58	16	58	29,5	87,5	38	9	6,5	6	30
50	40	M8	60	100	70	20	70	29	99	46,5	10	8,5	6	37
63	45	M8	65	110	85	20	85	37	122	56,5	13	8,5	6	37
80	45	M10	75	125	100	25	100	40,5	140,5	72	16	10,5	8	46
100	55	M10	90	152	116	25	116	59	179	89	18	10,5	8	51

Flange for female piston rod (standard supplied for RQ series)



Material: Aluminium

Cylinder Ø	Mass g	Part no.
32	24	RPF-28032
40	35	RPF-28040
50	57	RPF-28050
63	94	RPF-28063
80 - 100	-	-

DF sensor

Cable clamping for DF sensor

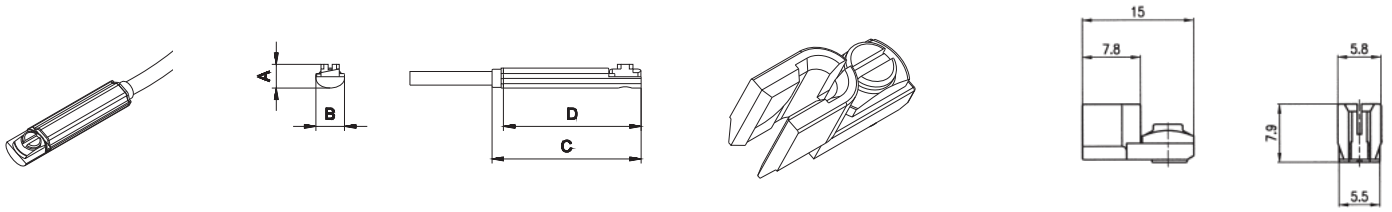

A	B	C	D	Part no.	A	B	C	D	E	Part no.
5,2	6,3	32,7	30,2	DF-___	15	7,8	7,9	5,8	5,5	DF-001

DF sensor

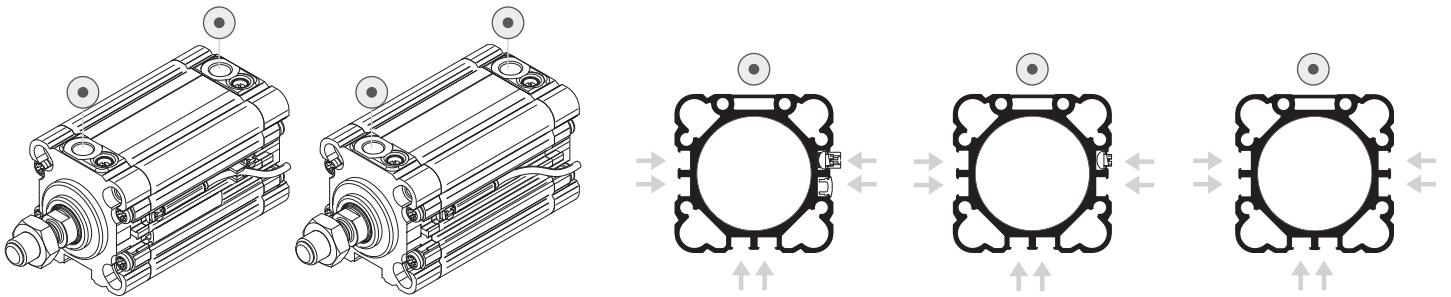

supply port