

# PK

## ISO 15552 Stainless steel pneumatic cylinders - Ø 32 ÷ 125 mm

- Stainless steel AISI 316
- Double acting versions
- Through piston rod versions
- FDA approved piston seals
- Execution with or without magnet

Available ATEX version upon request

CE II 2GDc T4

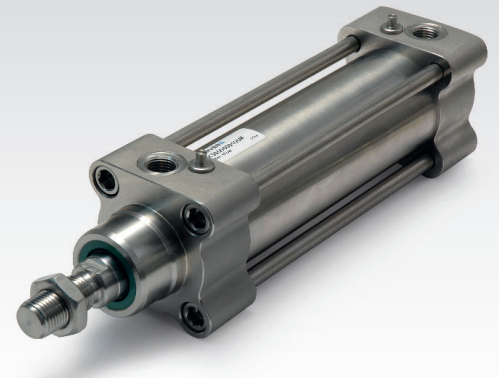

### TECHNICAL CHARACTERISTICS

Ambient temperature	0 ÷ 80 °C (-20 °C with dry air) 0 ÷ 150 °C (with high temperature seals)
Fluid	compressed air, filtered air, not lubricated
Working pressure	1 ÷ 10 bar
Bores	Ø 32 - 40 - 50 - 63 - 80 - 100 - 125 mm
Cushionings	adjustable on both sides

### CONSTRUCTIVE CHARACTERISTICS

End-caps	stainless steel AISI 316
Barrel	stainless steel AISI 316
Piston	die-cast aluminium
Guide slide	PBT+PTFE
Piston rod	stainless steel AISI 316
Piston seal	polyurethane
Guide bush for piston rod	sintered bronze
Magnet	plastroferrite
O-Ring	nitrile rubber (NBR)
Tie-rods	stainless steel AISI 316

### CODIFICATION KEY

P	K	3	0	0	0	3	2	0	0	2	5	M	
1	2	3	4			5			6	7			

1 Series	2 Type	3 Version	4 Bore (mm)
PK = Ø 32 ÷ 125 - ISO 15552 mm Stainless steel pneumatic cylinders	3 = Male piston rod	00 = D.A. Standard 01 = D.A. Through piston rod  D.A. = Double acting	032 = Ø32 080 = Ø80 040 = Ø40 100 = Ø100 050 = Ø50 125 = Ø125 063 = Ø63
5 Stroke (mm)	6 Magnetic	7 ATEX option	
0025 = 25 0150 = 150 0320 = 320 0600 = 600 0850 = 850 0050 = 50 0160 = 160 0400 = 400 0650 = 650 0900 = 900 0080 = 80 0200 = 200 0450 = 450 0700 = 700 0950 = 950 0100 = 100 0250 = 250 0500 = 500 0750 = 750 1000 = 1000 0125 = 125 0300 = 300 0550 = 550 0800 = 800	M = Magnetic version (standard supplied)	X = Atex (upon request)  For types and versions please contact our Sales Office	

Version with high temperature seals (Max 150°C) available upon request.

Fixing elements and accessories

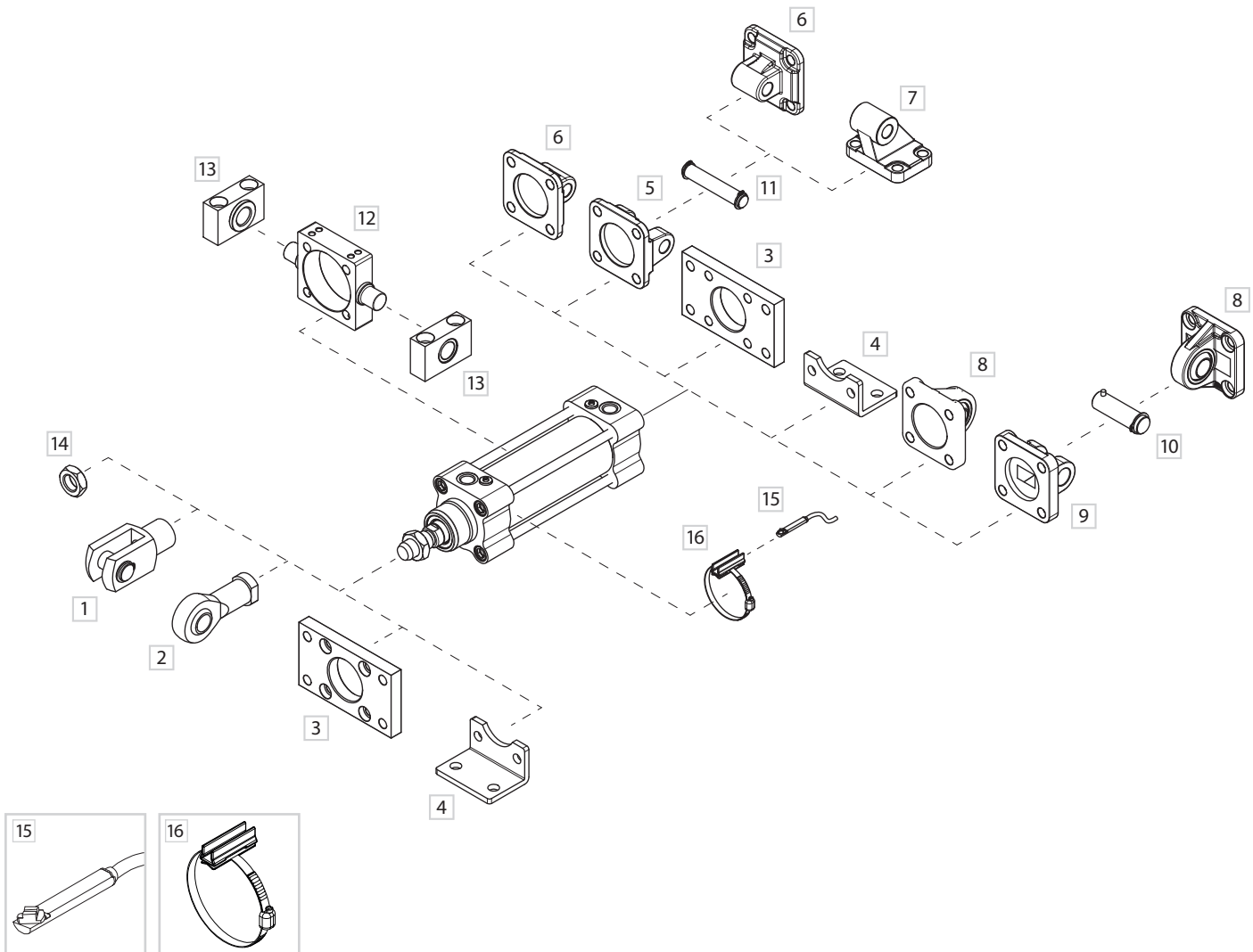

DESCRIPTION	NOTE	PART NO.
1 Female fork with pin	Stainless steel	KF-15 __ _PI
2 Articulated self-lubricating fork	Stainless steel	KF-17 __ _I
3 Front/rear flange (ISO MF1-MF2)	Stainless steel	KF-12 __ _I
4 Angle bracket (ISO MS1)	Stainless steel	KF-13 __ _I
5 Female hinge (ISO MP2)	Stainless steel	KF-10 __ _AI
6 Rear male hinge (ISO MP4)	Stainless steel	KF-11 __ _I
7 Counter hinge 90° (CETOP RP107P)	Stainless steel	KF-19 __ _CTAI
8 Articulated rear male hinge (ISO MP6)	Stainless steel	KF-11 __ _SI
9 Narrow female hinge with pin (DIN648K)	Stainless steel	KF-10 __ _ASI/
10 Narrow hinge pin (DIN648K)	Stainless steel	KF-18S I
11 Female hinge pin (ISO MS1)	Stainless steel	KF-18 _I
12 Intermediate hinge for tie-rods	Stainless steel	KF-14 __ _TI
13 Hinge support	Stainless steel	KF-41 __ _I
14 Piston rod nut	Stainless steel	KF-16 __ _I
15 DF sensor	-	DF-P700L06
16 DF bracket and adapter	Stainless steel	DH-P __ _DFI

### Double acting

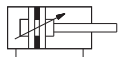
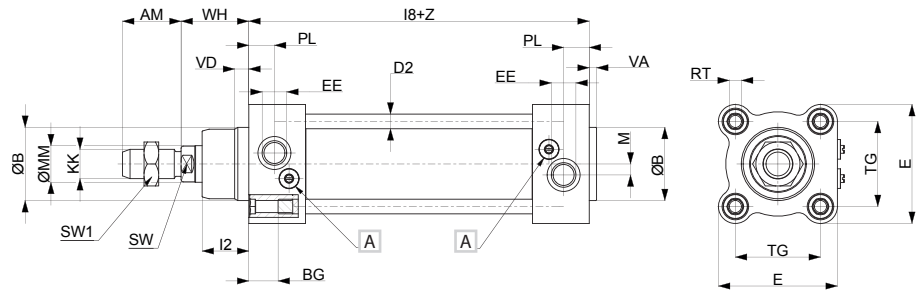

**PK300**  
D.A. Standard

### Double acting through piston rod

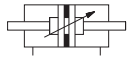

**PK301**  
D.A. Through piston rod

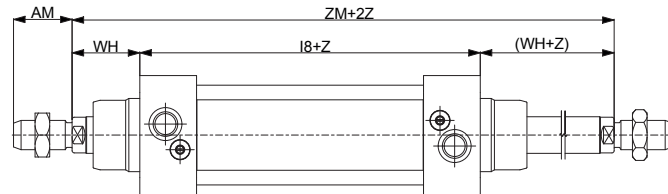

Z= Stroke

Ø	AM	ØB	BG	E	KK	I2	I8	PL	RT	SW	TG	VA	VD	WH	ØMM	EE	M	SW1	D2	ZM
32	22	30	16	48	M10x1,25	18	94 ±0,4	13	M6	10	32,5 ±0,5	4	5	26	12	G1/8	5,3	17	6	146
40	24	35	16	52	M12x1,25	22	105 ±0,7	14	M6	13	38 ±0,5	4	5	30	16	G1/4	5	19	6	165
50	32	40	16	65	M16x1,5	25,5	106 ±0,7	14	M8	17	46,5 ±0,6	4	6	37	20	G1/4	6	24	8	180
63	32	45	16	75	M16x1,5	26	121 ±0,8	16	M8	17	56,5 ±0,7	4	6	37	20	G3/8	6,5	24	8	195
80	40	45	18	95	M20x1,5	32	128 ±0,8	16	M10	22	72 ±0,7	4	7	46	25	G3/8	8	30	10	220
100	40	55	18	115	M20x1,5	38	138 ±1	18	M10	22	89 ±0,7	4	7	51	25	G1/2	7	30	10	240
125	54	60	20	140	M27x2	46	160 ±1	18	M12	27	110 ±1,1	6	10	65	32	G1/2	7	41	12	290

A Adjusting screw for pneumatic cushioning

Female hinge (ISO MP2) with pin

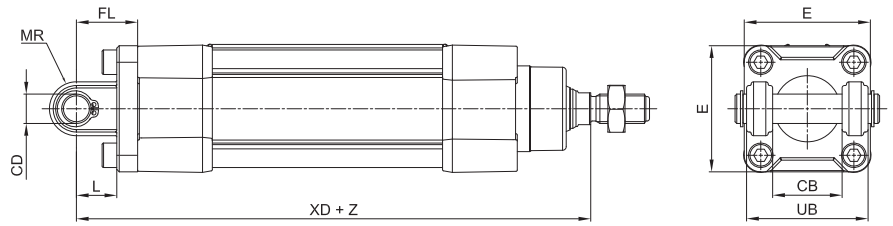
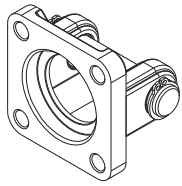

Material: Stainless steel AISI 304

Z = Stroke

Ø	CB	CD	E	FL	L	MR	UB	XD		Part no.
	H14	H9		± 0,2	min	Max	h14			
32	26	10	48	22	12	11	45	142	±1,25	KF-10032AI
40	28	12	54	25	15	13	52	160	±1,25	KF-10040AI
50	32	12	65	27	15	13	60	170	±1,25	KF-10050AI
63	40	16	75	32	20	17	70	190	±1,6	KF-10063AI
80	50	16	95	36	20	17	90	210	±1,6	KF-10080AI
100	60	20	115	41	25	21	110	230	±1,6	KF-10100AI
125	70	25	140	50	30	26	130	275	±2	KF-10125AI

Narrow female hinge with pin (DIN648K)

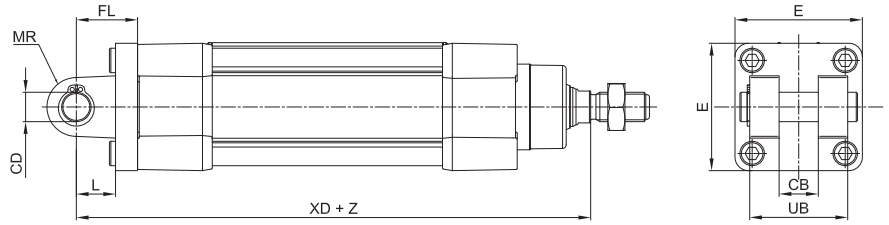
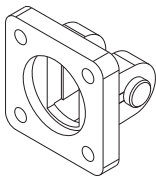

Material: Stainless steel AISI 316

Z = Stroke

Ø	CB	CD	E	FL	L	MR	UB	XD		Part no.
	H14	H9		± 0,2	min	Max	h14			
32	14	10	45	22	10	10	34	142	±1,25	KF-10032ASI
40	16	12	52	25	16	12	40	160	±1,25	KF-10040ASI
50	21	16	65	27	16	14	45	170	±1,5	KF-10050ASI
63	21	16	75	32	21	18	51	190	±1,6	KF-10063ASI
80	25	20	95	36	22	20	65	210	±1,6	KF-10080ASI
100	25	20	115	41	27	22	75	230	±1,6	KF-10100ASI
125	37	30	140	50	30	25	97	275	±2	KF-10125ASI

Female hinge pin

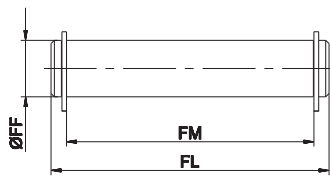

Including 2 circlips

Material: Stainless steel AISI 304

Ø	FF	FL	FM	Part no.
32	f8			
32	10	53	46	KF-18032I
40	12	61,3	53	KF-18040I
50	12	69	61	KF-18050I
63	16	80,5	71	KF-18063I
80	16	100,5	91	KF-18080I
100	20	122,5	111	KF-18100I
125	25	140	131	KF-18125I

Narrow female hinge pin

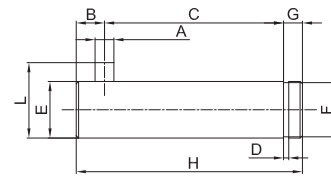

Including 2 circlips

Material: Stainless steel AISI 316

Ø	A	C	D	E	F	G	H	L	B	Part no.
	H12	$\begin{matrix} +0,5 \\ -0,3 \end{matrix}$	h13	f7	h11			$\begin{matrix} 0 \\ -0,5 \end{matrix}$		
32	3	32,5	1,1	10	9,6	4	41	14	4,5	KF-18032SI
40	4	38	1,1	12	11,5	4	48	16	6	KF-18040SI
50	4	43	1,1	16	15,2	5	54	20	6	KF-18050SI
63	4	49	1,1	16	15,2	5	60	20	6	KF-18063SI
80	4	63	1,3	20	19	6	75	24	6	KF-18080SI
100	4	73	1,3	20	19	6	85	24	6	KF-18100SI
125	6	94	1,6	30	28,6	7	110	36	9	KF-18125SI

Rear male hinge (ISO MP4)

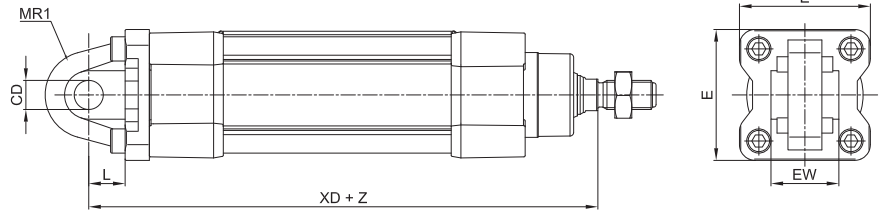
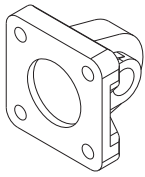

Material: Stainless steel AISI 304

Z = Stroke

Ø	CD	E	EW		L	MR1	XD		Part no.
	H9				min				
32	10	48	26	-0,2 / -0,6	12	15*	142	±1,25	KF-11032I
40	12	54	28	-0,2 / -0,6	15	18*	160	±1,25	KF-11040I
50	12	65	32	-0,2 / -0,6	15	20*	170	±1,25	KF-11050I
63	16	75	40	-0,2 / -0,6	20	23*	190	±1,6	KF-11063I
80	16	95	50	-0,2 / -0,6	20	27*	210	±1,6	KF-11080I
100	20	115	60	-0,2 / -0,6	25	29,5*	230	±1,6	KF-11100I
125	25	140	70	-0,5 / -1,2	30	26	275	±2	KF-11125I

\* = Non-standard dimension

Articulated rear male hinge (ISO MP6)

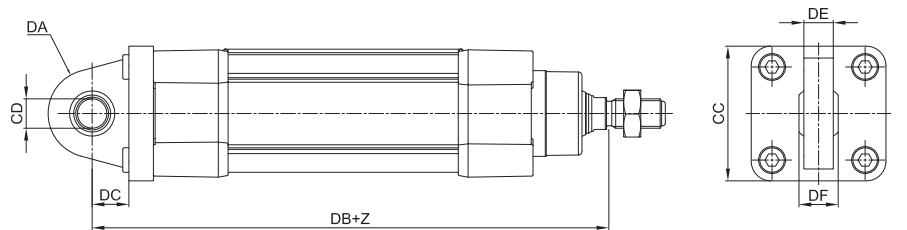
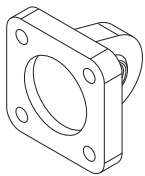

Material: Stainless steel AISI 316

Z = Stroke

Ø	CC	CD	DA	DB	DC	DE	DF	Part no.
		H9						
32	48	10	15	142	14	10,5	14	KF-11032SI
40	54	12	18	160	16,5	12	16	KF-11040SI
50	65	12	20	170	17,5	12	16	KF-11050SI
63	75	16	21	190	21,5	15	21	KF-11063SI
80	95	16	27	210	24	15	21	KF-11080SI
100	115	20	29,5	230	28	18	25	KF-11100SI
125	140	30	40	275	30	25	37	KF-11125SI

Front/rear flange (ISO MF1-MF2)

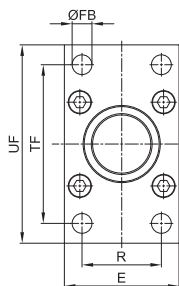
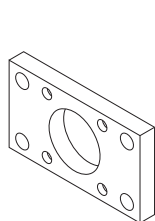

> Rear mounting

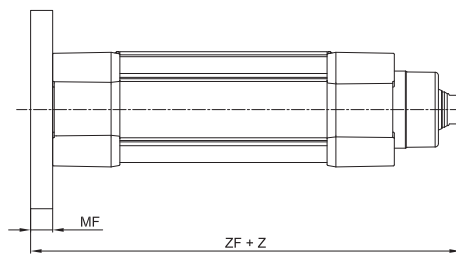

> Front mounting

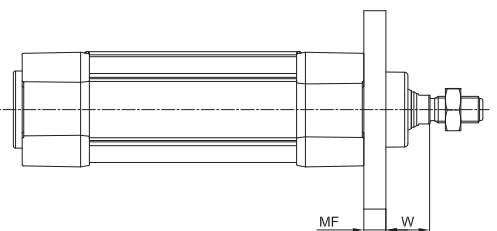

Material: Stainless steel AISI 304

Z = Stroke

Ø	E	FB	MF	R	TF	UF	W		ZF		Part no.
		H13	±0,2	JS14	JS14	Max					
32	45	7	10	32	64	80	16	±1,6	130	±1,25	KF-12032I
40	52	9	10	36	72	90	20	±1,6	145	±1,25	KF-12040I
50	65	9	12	45	90	110	25	±2	155	±1,25	KF-12050I
63	75	9	12	50	100	120	25	±2	170	±1,6	KF-12063I
80	95	12	16	63	126	150	30	±2	190	±1,6	KF-12080I
100	115	14	16	75	150	170	35	±2	205	±1,6	KF-12100I
125	140	16	20	90	180	205	45	±2,5	245	±2	KF-12125I

Angle bracket (ISO MS1)

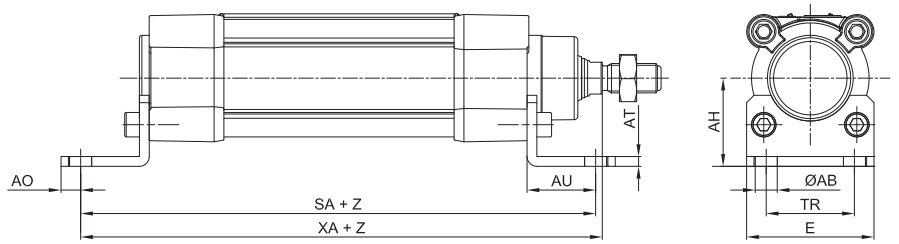
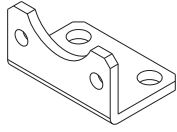

Material: Stainless steel AISI 304

Z = Stroke

Ø	ØAB	AH	AO	AT	AU	E	SA	TR	XA	Part no.		
	H13	JS15									±0,2	JS14
32	7	32	6	4	24	45	142	±1,25	32	144	±1,25	KF-13032I
40	9	36	8	4	28	52	161	±1,25	36	163	±1,25	KF-13040I
50	9	45	10	5	32	64	170	±1,25	45	175	±1,25	KF-13050I
63	9	50	12	5	32	74	185	±1,6	50	190	±1,6	KF-13063I
80	12	63	15	6	41	94	210	±1,6	63	215	±1,6	KF-13080I
100	14	71	20	6	41	114	220	±1,6	75	230	±1,6	KF-13100I
125	16	90	15	8	45	140	250	±2	90	270	±2	KF-13125I

Intermediate hinge for tie-rods

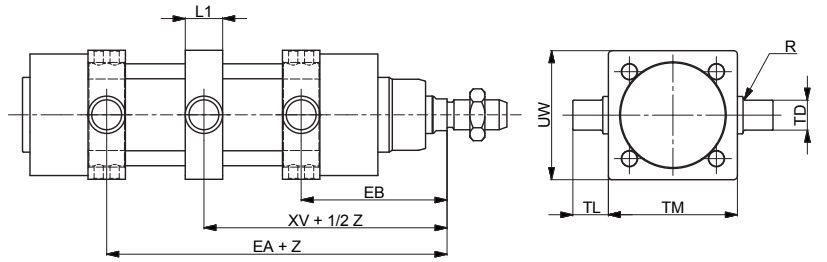
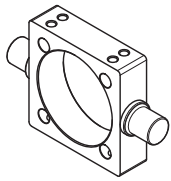

Material: Stainless steel AISI 304

Ø	EA	EB	L1	R	TD	TL	TM	UW	XV	Part no.	
	Max	min									e9
32	82	64	22	0,5	12	12	50	65	73	±2	KF-14032TI
40	93	72	22	0,5	16	16	63	75	82,5	±2	KF-14040TI
50	101	79	22	0,5	16	16	75	95	90	±2	KF-14050TI
63	107	88	27,5	1	20	20	90	105	97,5	±2	KF-14063TI
80	123	97	27,5	1,5	20	20	110	130	110	±2	KF-14080TI
100	131	109	33	1	25	25	132	145	120	±2	KF-14100TI
125	164	126	33	1	25	25	160	175	145	±2,5	KF-14125TI

Counter hinge 90° (CETOP RP107P)

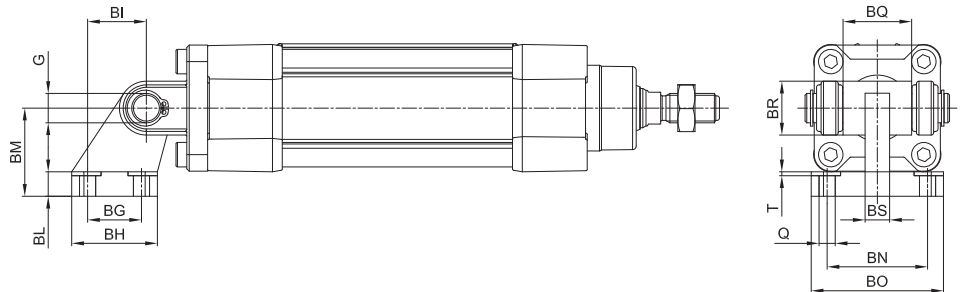
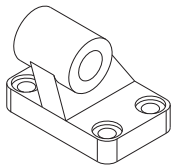

Material: Stainless steel AISI 304

Ø	Q	BG	BH	BI	BL	BM	BN	BO	BS	BR	T	G	Part no.
	H13	JS14	Max	JS14		JS15	JS14	Max	Max	Max	Max	H9	
32	6,6	18	31	21	8	32	38	51	10	20	1,6	10	KF-19032CTAI
40	6,6	22	35	24	10	36	41	54	15	22	1,6	12	KF-19040CTAI
50	9	30	45	33	12	45	50	65	16	26	1,6	12	KF-19050CTAI
63	9	35	50	37	14	50	52	67	16	30	1,6	16	KF-19063CTAI
80	11	40	60	47	14	63	66	86	20	30	2,5	16	KF-19080CTAI
100	11	50	70	55	17	71	76	96	20	38	2,5	20	KF-19100CTAI
125	14	60	90	70	20	90	94	124	30	45	3,2	25	KF-19125CTAI

Hinge support

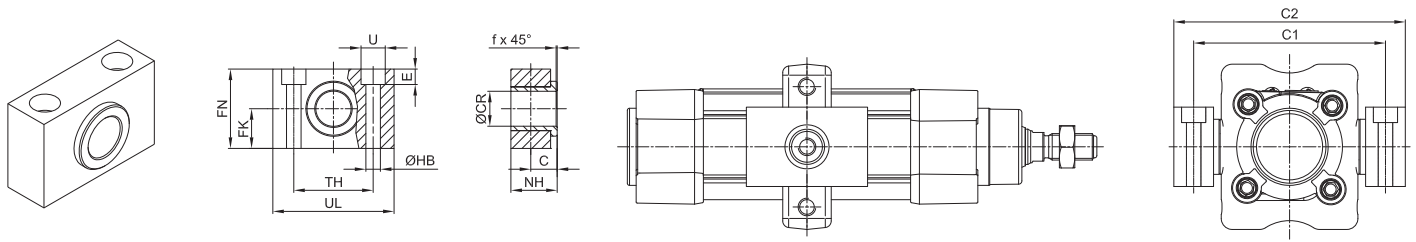

Material: Stainless steel AISI 304

Ø	C	ØCR	FK	FN	ØHB	NH	TH	UL	ØU	E	f	C1	C2	Part no.
	H9	f7	±0,1				±0,1			±0,5				
32	10,5	12	15	30	6,6	18	32	46	11	7	1	71	86	KF-41032I
40	12	16	18	36	9	21	36	55	15	9	1,6	87	105	KF-41040050I
50	12	16	18	36	9	21	36	55	15	9	1,6	99	117	KF-41040050I
63	13	20	20	40	11	23	42	65	18	11	1,6	116	136	KF-41063080I
80	13	20	20	40	11	23	42	65	18	11	1,6	136	156	KF-41063080I
100	16	25	25	50	14	28,5	50	75	20	13	2	164	189	KF-41100125I
125	16	25	25	50	14	28,5	50	75	20	13	2	192	217	KF-41100125I

Female fork with pin

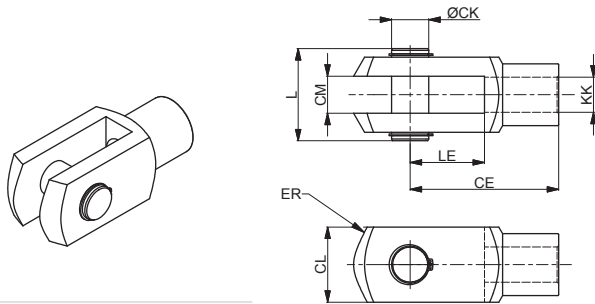

Material: Stainless steel AISI 304

Ø	CE	CK	CL	CM	ER	KK	L	LE	Part no.
	B12								
32	40	10	20	10	16	M10x1,25	26	20	KF-15032PI
40	48	12	24	12	19	M12x1,25	32	24	KF-15040PI
50 - 63	64	16	32	16	25	M16x1,5	40	32	KF-15050PI
80 - 100	80	20	40	20	32	M20x1,5	50	40	KF-15080PI
125	110	30	55	30	45	M27x2	65	54	KF-15125PI

Fork with clip suitable for piston rod according to ISO 8140

Articulated self-lubricating fork

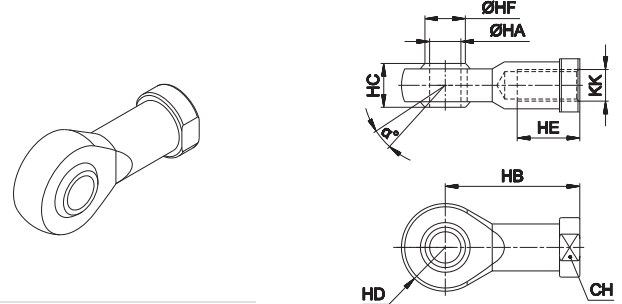

Material: Stainless steel AISI 304

Ø	α°	CH	KK	HA	HB	HC	HD	HE	HF	Part no.
		H7	H7	H7	0 -0,12					
32	13	17	M10x1,25	10	43	14	14	20	12,9	KF-17032I
40	13	19	M12x1,25	12	50	16	16	22	15,4	KF-17040I
50 - 63	15	22	M16x1,5	16	64	21	21	28	19,3	KF-17050I
80 - 100	14	30	M20 x 1,5	20	77	25	25	33	24,3	KF-17080I
125	17	41	M27x2	30	110	37	35	51	34,8	KF-17125I

Piston rod nut



Material: Stainless steel AISI 304

Ø	KK	KV	KW	Part no.
32	M10x1,25	17	6	KF-16032I
40	M12x1,25	19	7	KF-16040I
50 - 63	M16x1,5	24	8	KF-16050I
80 - 100	M20x1,5	30	9	KF-16080I
125	M27x2	41	12	KF-16125I

DF bracket

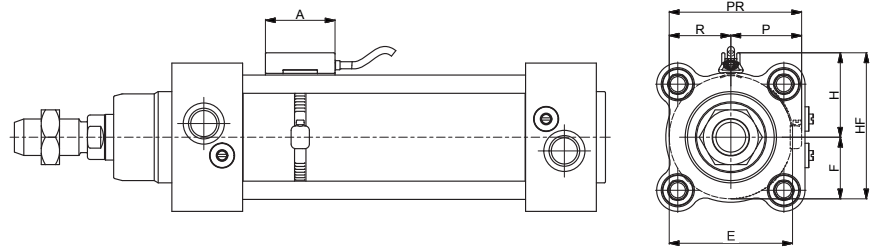
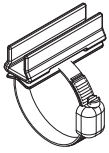

Material: Stainless steel AISI 303

Ø	A	E	H	F	HF	P	R	PR	Part no.
32	34	33,5	45	16,75	78,5	39	33,5	72,5	DH-P025032DFI
40	34	41,5	53	20,75	94,5	47	41,5	88,5	DH-P040DFI
50	34	51,5	63	25,75	114,5	57	51,5	108,5	DH-P050DFI
63	34	64,5	76	32,25	140,5	70	64,5	134,5	DH-P063DFI
80	34	81,5	93	40,75	174,5	87	81,5	168,5	DH-P080DFI
100	34	101,5	113	50,75	214,5	107	101,5	208,5	DH-P100DFI
125	34	126,5	138	63,25	264,5	132	126,5	258,5	DH-P125DFI

For DF sensors see accessories section

DF sensor

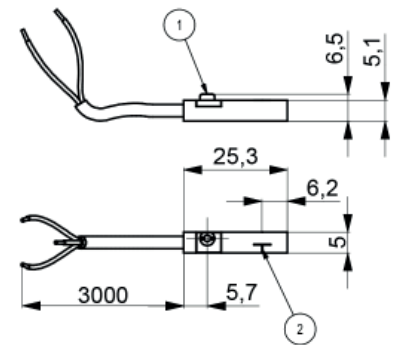
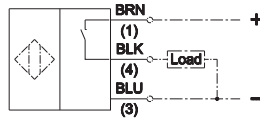
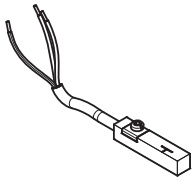

1	2	Part no.
fixing eccentric	active sensing face	DF-P700L06