

Stock Code	Stock Name	Weight (gr)
5.1.01.040086.01.20	Ø20 Roller Block Guide	9500
6.1.01.040086.165185.1.4	Ø20 Block Guide Carriage	2570
6.1.01.040086.165185.3.4	Ø20 Block Guide Carriage with Single Lock	2750
6.1.01.040086.165185.4.4	Ø20 Block Guide Carriage with Double Lock	2930
6.1.02.040086.165185.1.4	Ø20 Block Guide Carriage (with Shield / Lubrication)	3500

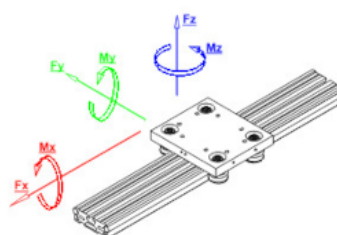
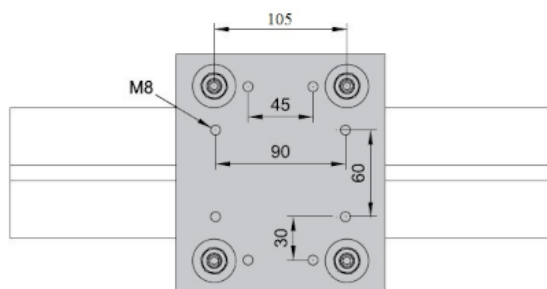
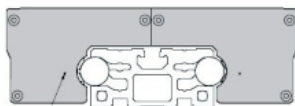
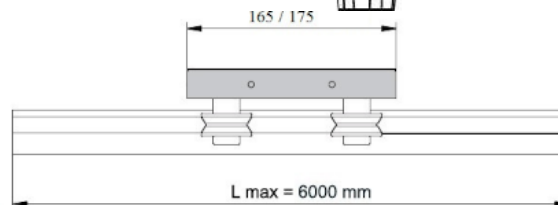
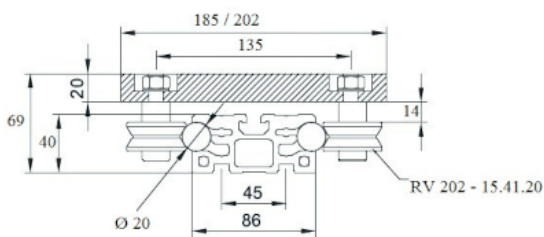
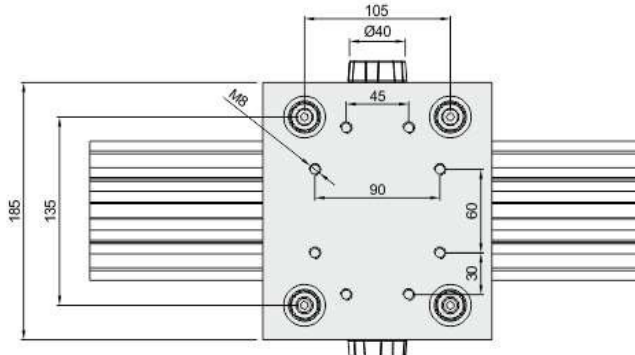
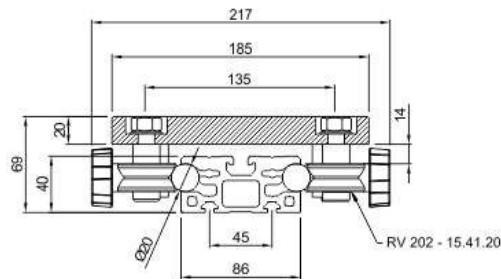
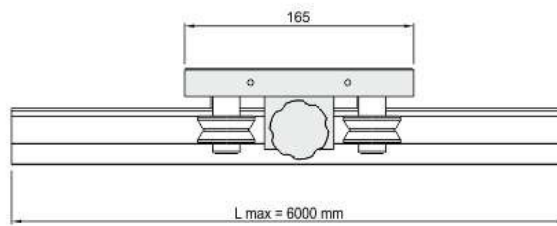
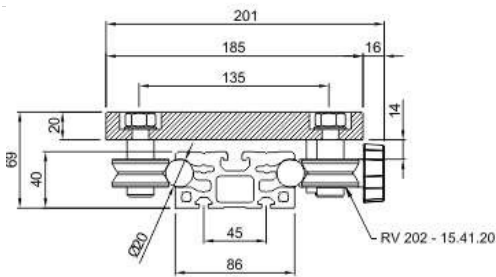

■ F_x	(N)	
■ F_y	(N)	1260
■ F_z	(N)	1870
Moment		
■ M_x	(Nm)	95
■ M_y	(Nm)	85
■ M_z	(Nm)	115