

Ø 75 DOUBLE WHEEL

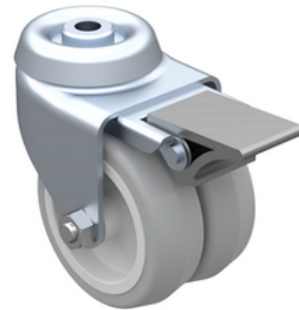
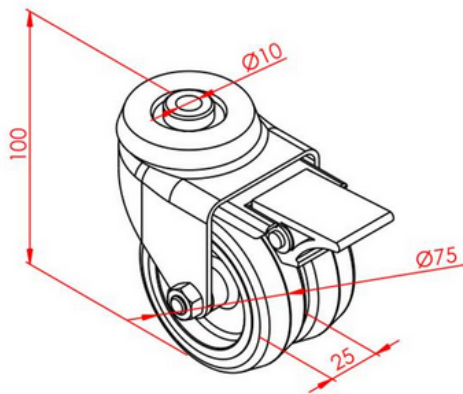

Stock Code	Stock Name	Loading Capacity	Material	Weight (gr)
2.3.004.075.02	Ø 75 Double Wheel	80 kg	Polyamid	538