

Ø 50 SINGLE WHEEL

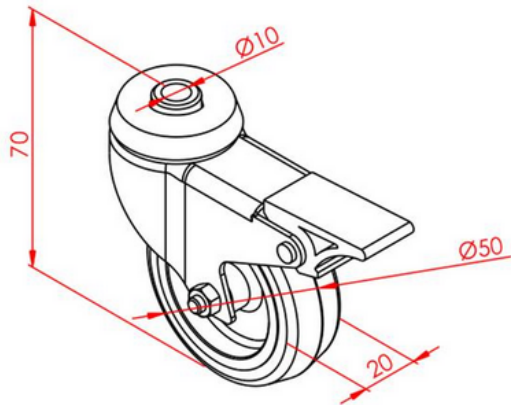

Stock Code	Stock Name	Loading Capacity	Material	Weight (gr)
2.3.004.050.01	Ø 50 Single Wheel	35 kg	Polyamid	204