

PRM

ISO 21287 Stainless steel compact pneumatic cylinders Ø 20 ÷ 100 mm

- Stainless steel AISI 316
- Double acting and single acting versions
- Through piston rod versions
- FDA approved piston seals

Available ATEX version upon request

CE II 2GDc T4

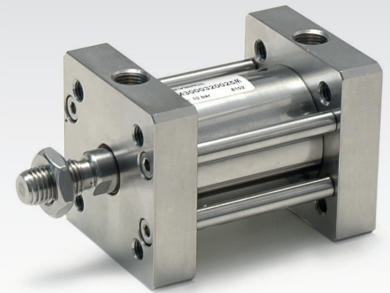

TECHNICAL CHARACTERISTICS

Ambient temperature	0 ÷ 80 °C (-20°C with dry air)
Fluid	compressed air, filtered air, not lubricated
Working pressure	1 ÷ 10 bar (double acting) 2 ÷ 10 bar (simple acting)
Bores	Ø 20 - 25 - 32 - 40 - 50 - 63 - 80 - 100 mm

CONSTRUCTIVE CHARACTERISTICS

End-caps	stainless steel AISI 316
Barrel	Ø20-25 stainless steel AISI 304, Ø32-100 stainless steel AISI 316
Piston	aluminium
Guide slide	PBT+PTFE
Piston rod	stainless steel AISI 316
Piston seal	polyurethane
Guide bush for piston rod	technopolymer
Magnet	Ø20÷50 neodimio, Ø63÷100 plastoferrite
O-Ring	nitrile rubber (NBR)
Tie-rods	stainless steel AISI 316

CODIFICATION KEY

P	R	M	3	0	0	0	3	2	0	0	2	5	M	
1	2	3	4	5			6	7						

1 Series	2 Type	3 Version	4 Bore (mm)
PRM = Ø 20 ÷ 100 mm - ISO 21287 Stainless steel compact pneumatic cylinders	1 = Female piston rod 3 = Male piston rod	00 = D.A. Standard 01 = D.A. Through piston rod 60 = S.A. Retracted piston rod 70 = S.A. Extended piston rod D.A. = Double acting S.A. = Single acting	020 = Ø20 050 = Ø50 025 = Ø25 063 = Ø63 032 = Ø32 080 = Ø80 040 = Ø40 100 = Ø100
5 Stroke (mm)	6 Magnetic	7 ATEX option	
0010 = 10 0100 = 100 0250 = 250 0025 = 25 0125 = 125 0300 = 300 0050 = 50 0160 = 160 0350 = 350 0075 = 75 0200 = 200 0400 = 400	M = Magnetic version (standard supplied)	X = Atex (upon request) For types and versions please contact our Sales Office	

Version with high temperature seals (Max 150°C) available upon request.

Fixing elements and accessories

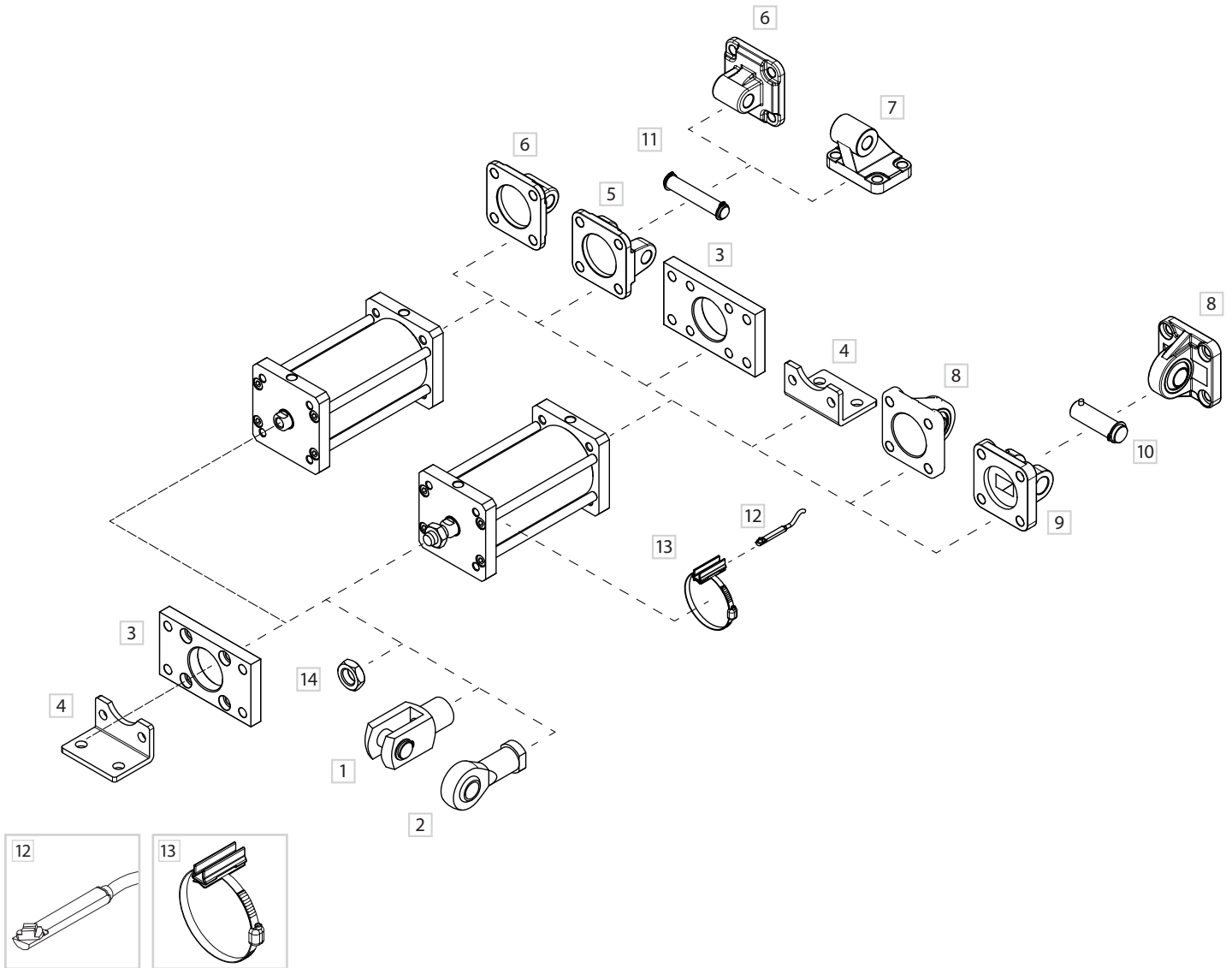

DESCRIPTION	NOTE	PART NO.
1 Female fork with pin	Stainless steel	KF-15 __ _PI
2 Articulated self-lubricating fork	Stainless steel	KF-17 __ _I
3 Front/rear flange (ISO MF1-MF2)	Stainless steel	KF-12 __ _I
4 Angle bracket (ISO MS1)	Stainless steel	KF-13 __ _I
5 Female hinge (ISO MP2)	Stainless steel	KF-10 __ _AI
6 Rear male hinge (ISO MP4)	Stainless steel	KF-11 __ _I
7 Counter hinge 90° (CETOP RP107P)	Stainless steel	KF-19 __ _CTAI
8 Articulated rear male hinge (ISO MP6)	Stainless steel	KF-11 __ _SI
9 Narrow female hinge with pin (DIN648K)	Stainless steel	KF-10 __ _ASI/
10 Narrow hinge pin (DIN648K)	Stainless steel	KF-18S I
11 Female hinge pin (ISO MS1)	Stainless steel	KF-18 _I
12 DF sensor	-	DF-P700L06
13 DF bracket and adapter	Stainless steel	DH-P __ _DFI
14 Piston rod nut	Stainless steel	KF-16 __ _I

Double acting

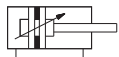

PRM100/PRM300
D.A. Standard

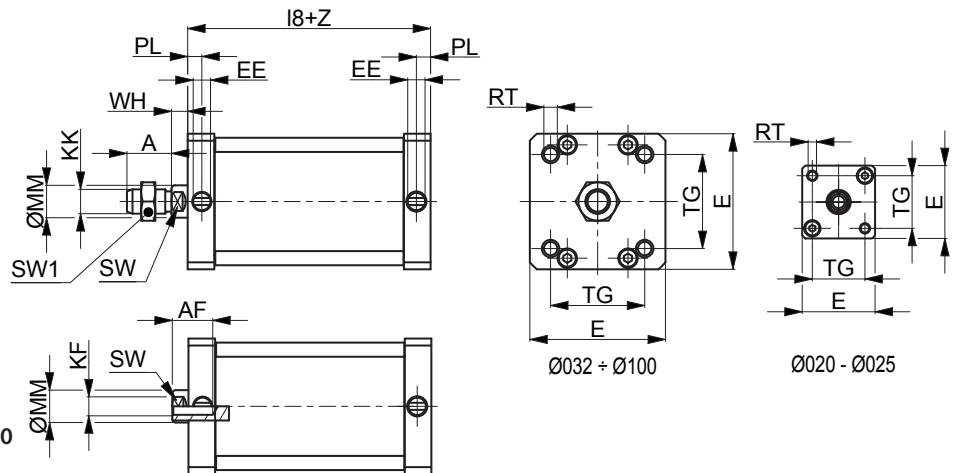

Double acting through piston rod

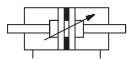

PRM101/PRP301
D.A. Through piston rod

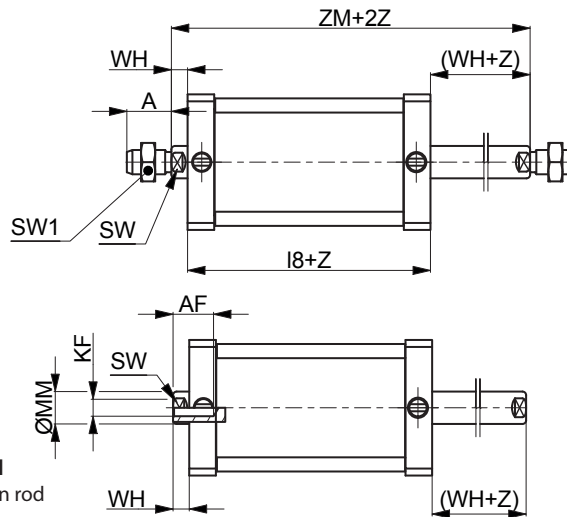

Z= Stroke

Ø	A	AF	KF	E±0,5	KK	I8	PL	RT	SW	TG	WH	ØMM	EE	SW1	ZM		
20	16	10	M6	32	M8	37	±0,3	6	M5	8	22	±0,3	6,5	10	M5x0,8	13	43,5
25	16	10	M6	36	M8	39	±0,3	6	M5	8	26	±0,3	6	10	M5x0,8	13	45
32	19	12	M8	50	M10x1,25	44	±0,4	7	M6	10	32,5	±0,5	6,5	12	G1/8	17	50,5
40	19	12	M8	57	M10x1,25	45	±0,7	7	M6	10	38	±0,6	7	12	G1/8	17	52
50	22	16	M10	67	M12x1,25	45	±0,7	7	M8	13	46,5	±0,7	8	16	G1/8	19	53
63	22	16	M10	80	M12x1,25	49	±0,8	7	M8	13	56,5	±0,7	8	16	G1/8	19	57
80	28	20	M12	96	M16x1,5	54	±0,8	7,5	M10	17	72	±0,7	10	20	G1/8	24	64
100	28	20	M12	116	M16x1,5	67	±1	7,5	M10	22	89	±1,1	10	25	G1/8	24	77

Single acting retracted piston rod

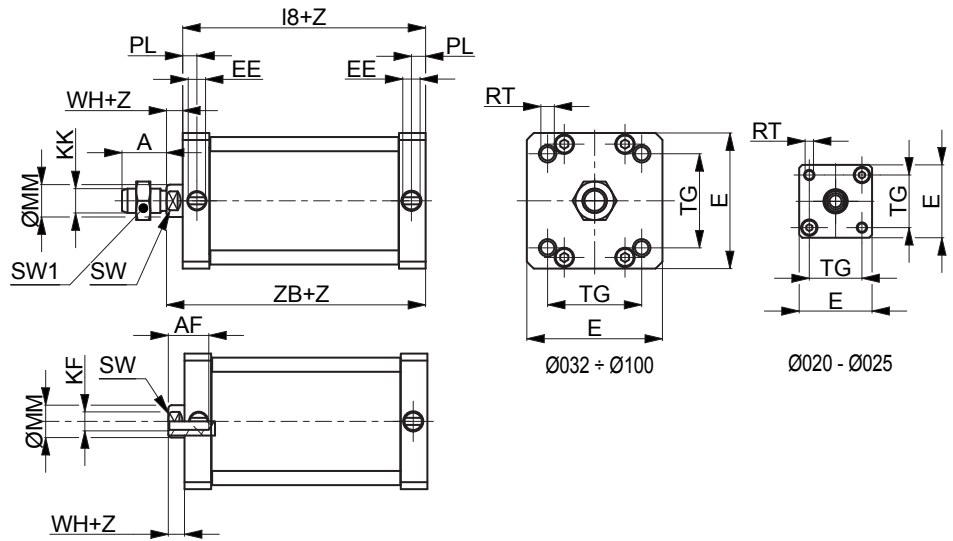

PRM160/PRM360
S.A. Retracted piston rod

Z= Stroke

Ø	A	AF	KF	E+0,5	KK	I8	PL	RT	SW	TG	WH	ØMM	EE	SW1	ZB		
20	16	10	M6	32	M8	47	±0,3	6	M5	8	22	±0,3	6,5	10	M5x0,8	13	53,5
25	16	10	M6	36	M8	49	±0,3	6	M5	8	26	±0,3	6	10	M5x0,8	13	55
32	19	12	M8	50	M10x1,25	44	±0,4	7	M6	10	32,5	±0,5	6,5	12	G1/8	17	50,5
40	19	12	M8	57	M10x1,25	45	±0,7	7	M6	10	38	±0,6	7	12	G1/8	17	52
50	22	16	M10	67	M12x1,25	45	±0,7	7	M8	13	46,5	±0,7	8	16	G1/8	19	53
63	22	16	M10	80	M12x1,25	49	±0,8	7	M8	13	56,5	±0,7	8	16	G1/8	19	57
80	28	20	M12	96	M16x1,5	54	±0,8	7,5	M10	17	72	±0,7	10	20	G1/8	24	64
100	28	20	M12	116	M16x1,5	67	±1	7,5	M10	22	89	±1,1	10	25	G1/8	24	77

Single acting extended piston rod

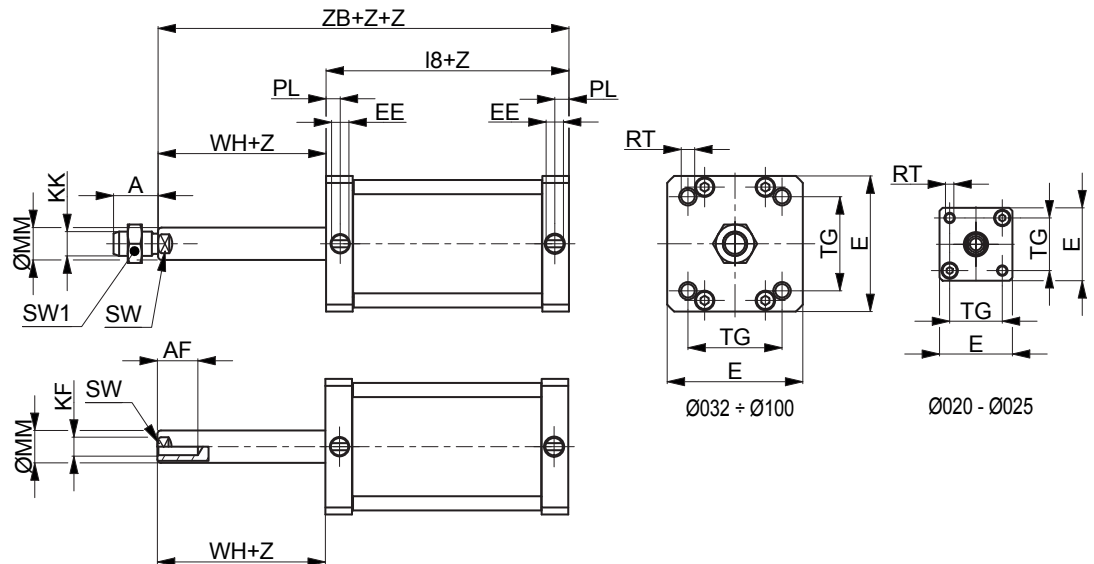

PRM170/PRM370
S.A. Extended piston rod

Z= Stroke

Ø	A	AF	KF	E+0,5	KK	I8	PL	RT	SW	TG	WH	ØMM	EE	SW1	ZB		
20	16	10	M6	32	M8	47	±0,3	6	M5	8	22	±0,3	6,5	10	M5x0,8	13	53,5
25	16	10	M6	36	M8	49	±0,3	6	M5	8	26	±0,3	6	10	M5x0,8	13	55
32	19	12	M8	50	M10x1,25	44	±0,4	7	M6	10	32,5	±0,5	6,5	12	G1/8	17	50,5
40	19	12	M8	57	M10x1,25	45	±0,7	7	M6	10	38	±0,6	7	12	G1/8	17	52
50	22	16	M10	67	M12x1,25	45	±0,7	7	M8	13	46,5	±0,7	8	16	G1/8	19	53
63	22	16	M10	80	M12x1,25	49	±0,8	7	M8	13	56,5	±0,7	8	16	G1/8	19	57
80	28	20	M12	96	M16x1,5	54	±0,8	7,5	M10	17	72	±0,7	10	20	G1/8	24	64
100	28	20	M12	116	M16x1,5	67	±1	7,5	M10	22	89	±1,1	10	25	G1/8	24	77

Female hinge (ISO MP2) with pin

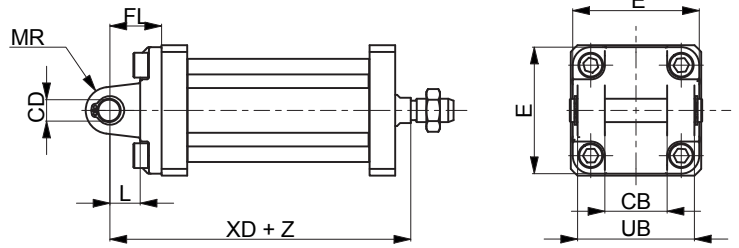
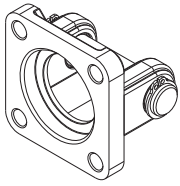

Material: Stainless steel AISI 304

Z = Stroke

Ø	CB	CD	E	FL	L	MR	UB	XD	Part no.	
	H14	H9		± 0,2						min
20	-	-	-	-	-	-	-	-	-	
25	-	-	-	-	-	-	-	-	-	
32	26	10	48	22	12	11	45	62,5	±1,25	KF-10032AI
40	28	12	54	25	15	13	52	67	±1,25	KF-10040AI
50	32	12	65	27	15	13	60	68	±1,25	KF-10050AI
63	40	16	75	32	20	17	70	77	±1,6	KF-10063AI
80	50	16	95	36	20	17	90	84	±1,6	KF-10080AI
100	60	20	115	41	25	21	110	102	±1,6	KF-10100AI

Narrow female hinge with pin (DIN648K)

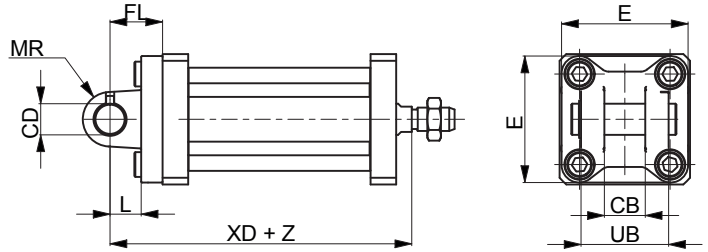
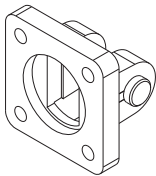

Material: Stainless steel AISI 316

Z = Stroke

Ø	CB	CD	E	FL	L	MR	UB	XD	Part no.	
	H14	H9		± 0,2						min
20	-	-	-	-	-	-	-	-	-	
25	-	-	-	-	-	-	-	-	-	
32	14	10	45	22	10	10	34	60,5	±1,25	KF-10032ASI
40	16	12	52	25	16	12	40	68	±1,25	KF-10040ASI
50	21	16	65	27	16	14	45	69	±1,5	KF-10050ASI
63	21	16	75	32	21	18	51	78	±1,6	KF-10063ASI
80	25	20	95	36	22	20	65	86	±1,6	KF-10080ASI
100	25	20	115	41	27	22	75	104	±1,6	KF-10100ASI

Female hinge pin

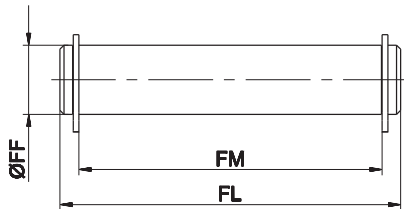

Including 2 circlips

Material: Stainless steel AISI 304

Ø	FF	FL	FM	Part no.
	f8			
20	-	-	-	-
25	-	-	-	-
32	10	53	46	KF-18032I
40	12	61,3	53	KF-18040I
50	12	69	61	KF-18050I
63	16	80,5	71	KF-18063I
80	16	100,5	91	KF-18080I
100	20	122,5	111	KF-18100I

Narrow female hinge pin

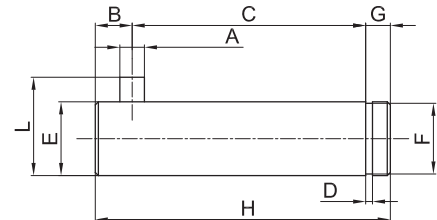

Including 2 circlips

Material: Stainless steel AISI 316

Ø	A	C	D	E	F	G	H	L	B	Part no.
	H12	$\begin{matrix} +0,5 \\ -0,3 \end{matrix}$	h13	f7	h11			$\begin{matrix} 0 \\ -0,5 \end{matrix}$		
20	-	-	-	-	-	-	-	-	-	-
25	-	-	-	-	-	-	-	-	-	-
32	3	32,5	1,1	10	9,6	4	41	14	4,5	KF-18032SI
40	4	38	1,1	12	11,5	4	48	16	6	KF-18040SI
50	4	43	1,1	16	15,2	5	54	20	6	KF-18050SI
63	4	49	1,1	16	15,2	5	60	20	6	KF-18063SI
80	4	63	1,3	20	19	6	75	24	6	KF-18080SI
100	4	73	1,3	20	19	6	85	24	6	KF-18100SI

Rear male hinge (ISO MP4)

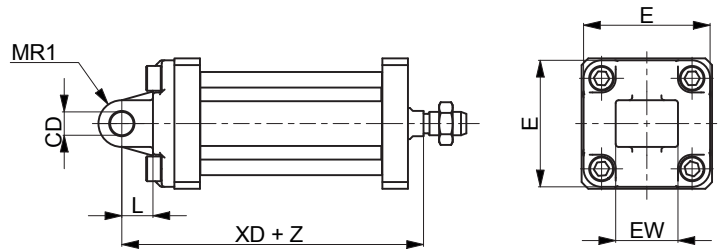
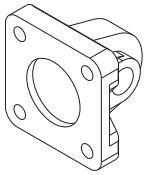

Material: Stainless steel AISI 304

Z = Stroke

Ø	CD	E	EW		L	MR1	XD		Part no.
	H9				min				
20	-	-	-	-	-	-	-	-	-
25	-	-	-	-	-	-	-	-	-
32	10	48	26	-0,2/-0,6	12	15*	62,5	±1,25	KF-11032I
40	12	54	28	-0,2/-0,6	15	18*	67	±1,25	KF-11040I
50	12	65	32	-0,2/-0,6	15	20*	68	±1,25	KF-11050I
63	16	75	40	-0,2/-0,6	20	23*	77	±1,6	KF-11063I
80	16	95	50	-0,2/-0,6	20	27*	84	±1,6	KF-11080I
100	20	115	60	-0,2/-0,6	25	29,5*	102	±1,6	KF-11100I

* = Non-standard dimension

Articulated rear male hinge (ISO MP6)

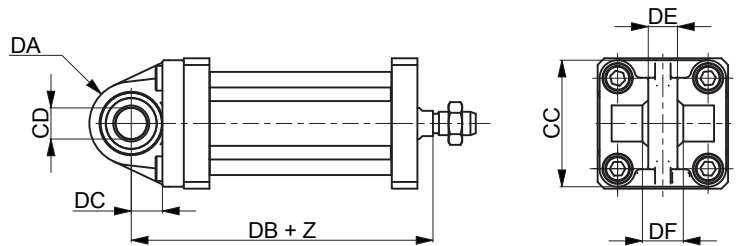
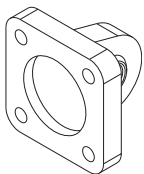

Material: Stainless steel AISI 316

Z = Stroke

Ø	CC	CD	DA	DB	DC	DE	DF	Part no.
		H9						
20	-	-	-	-	-	-	-	-
25	-	-	-	-	-	-	-	-
32	48	10	15	64	14	10,5	14	KF-11032SI
40	54	12	18	68,5	16,5	12	16	KF-11040SI
50	65	12	20	70,5	17,5	12	16	KF-11050SI
63	75	16	21	78,5	21,5	15	21	KF-11063SI
80	95	16	27	88	24	15	21	KF-11080SI
100	115	20	29,5	105	28	18	25	KF-11100SI

Front/rear flange (ISO MF1-MF2)

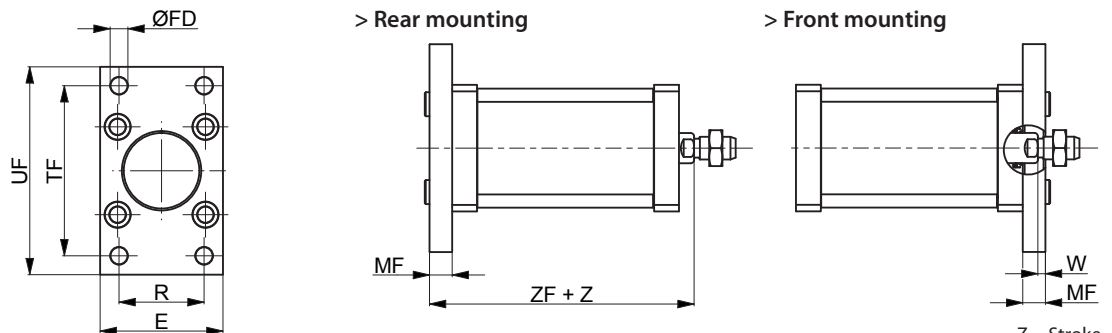
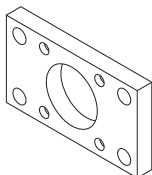

Material: Stainless steel AISI 304

Z = Stroke

Ø	E	FB	MF	R	TF	UF	W		ZF	Part no.
		H13	±0,2	JS14	JS14	Max				
20	-	-	-	-	-	-	-	-	-	-
25	-	-	-	-	-	-	-	-	-	-
32	45	7	10	32	64	80	3,5	±1,6	54	±1,25
40	52	9	10	36	72	90	3	±1,6	55	±1,25
50	65	9	12	45	90	110	4	±2	57	±1,25
63	75	9	12	50	100	120	4	±2	61	±1,6
80	95	12	16	63	126	150	6	±2	70	±1,6
100	115	14	16	75	150	170	6	±2	83	±1,6

Angle bracket (ISO MS1)

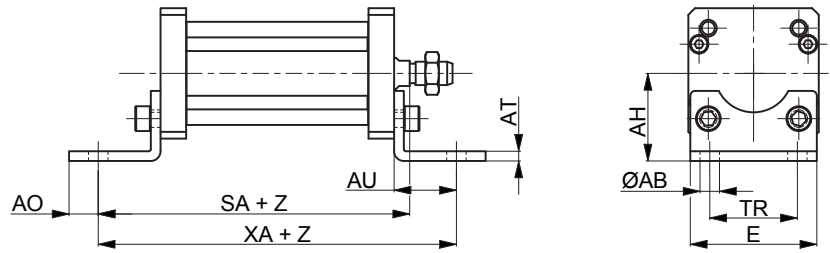
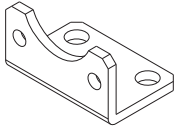

Material: Stainless steel AISI 304

Z = Stroke

Ø	ØAB	AH	AO	AT	AU	E	SA	TR	XA	Part no.		
	H13	JS15									±0,2	JS14
20	-	-	-	-	-	-	-	-	-	-		
25	-	-	-	-	-	-	-	-	-	-		
32	7	32	6	4	24	45	74,5	±1,25	32	98,5	±1,25	KF-13032I
40	9	36	8	4	28	52	80	±1,25	36	108	±1,25	KF-13040I
50	9	45	10	5	32	64	85	±1,25	45	117	±1,25	KF-13050I
63	9	50	12	5	32	74	89	±1,6	50	121	±1,6	KF-13063I
80	12	63	15	6	41	94	105	±1,6	63	146	±1,6	KF-13080I
100	14	71	20	6	41	114	118	±1,6	75	159	±1,6	KF-13100I

Counter hinge 90° (CETOP RP107P)

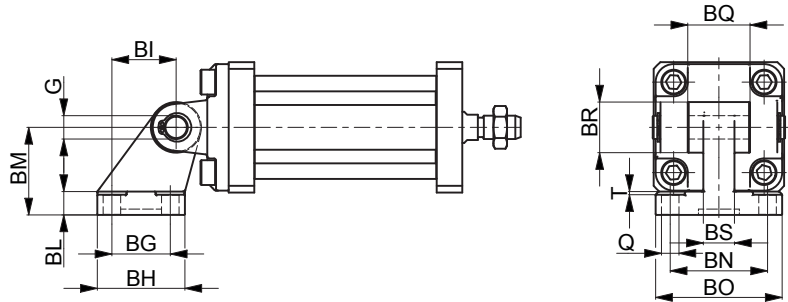
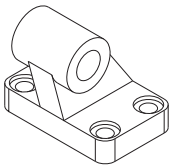

Material: Stainless steel AISI 304

Ø	Q	BG	BH	BI	BL	BM	BN	BO	BS	BR	T	G	Part no.
	H13	JS14	Max	JS14		JS15	JS14	Max	Max	Max	Max	H9	
20	-	-	-	-	-	-	-	-	-	-	-	-	-
32	6,6	18	31	21	8	32	38	51	10	20	1,6	10	KF-19032CTAI
40	6,6	22	35	24	10	36	41	54	15	22	1,6	12	KF-19040CTAI
50	9	30	45	33	12	45	50	65	16	26	1,6	12	KF-19050CTAI
63	9	35	50	37	14	50	52	67	16	30	1,6	16	KF-19063CTAI
80	11	40	60	47	14	63	66	86	20	30	2,5	16	KF-19080CTAI
100	11	50	70	55	17	71	76	96	20	38	2,5	20	KF-19100CTAI

Female fork with pin

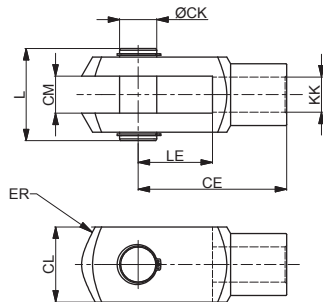
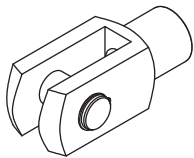

Material: Stainless steel AISI 304

Ø	CE	CK	CL	CM	ER	KK	L	LE	Part no.
20 - 25	32	8	16	8	10	M8x1,25	22	16	MF-15020PI
32 - 40	40	10	20	10	16	M10x1,25	26	20	KF-15032PI
50 - 63	48	12	24	12	19	M12x1,25	32	24	KF-15040PI
80 - 100	64	16	32	16	25	M16x1,5	40	32	KF-15050PI

Articulated self-lubricating fork

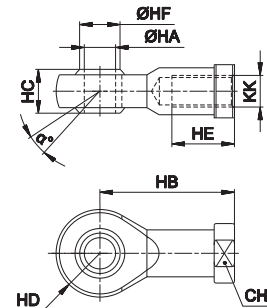
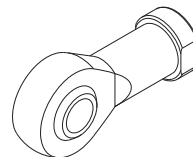

Material: Stainless steel AISI 304

Ø	α°	CH	KK	HA	HB	HC	HD	HE	HF	Part no.
20 - 25	14	14	M8x1,25	8	36	12	12	16	10,4	MF-17020I
32 - 40	13	17	M10x1,25	10	43	14	14	20	12,9	KF-17032I
50 - 63	13	19	M12x1,25	12	50	16	16	22	15,4	KF-17040I
80 - 100	15	22	M16x1,5	16	64	21	21	28	19,3	KF-17050I

Fork with clip suitable for piston rod according to ISO 8140

Piston rod nut

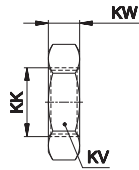

Material: Stainless steel AISI 304

Ø	KK	KV	KW	Part no.
20 - 25	M8x1,25	13	5	MF-16020I
32 - 40	M10x1,25	17	6	KF-16032I
50 - 63	M12x1,25	19	7	KF-16040I
80 - 100	M16x1,5	24	8	KF-16050I

DF bracket

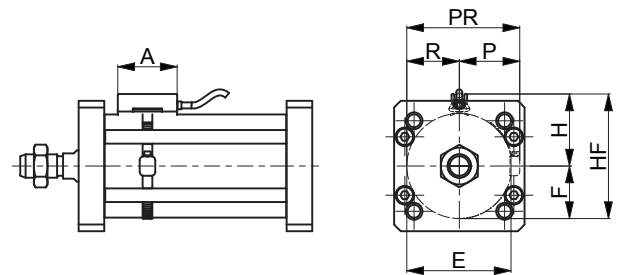
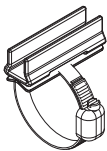

Material: Stainless steel AISI 303

Ø	A	E	H	F	HF	P	R	PR	Part no.
20	34	24	20	12	32	17	12	29	DH-P020DFI
25	34	32	23	16	39	19	16	35	DH-P025032DFI
32	34	41,5	53	16,75	94,5	47	41,5	88,5	DH-P025032DFI
40	34	51,5	63	20,75	114,5	57	51,5	108,5	DH-P040DFI
50	34	64,5	76	25,75	140,5	70	64,5	134,5	DH-P050DFI
63	34	81,5	93	32,25	174,5	87	81,5	168,5	DH-P063DFI
80	34	101,5	113	40,75	214,5	107	101,5	208,5	DH-P080DFI
100	34	126,5	138	50,75	264,5	132	126,5	258,5	DH-P100DFI

For DF sensors see accessories section

DF sensor

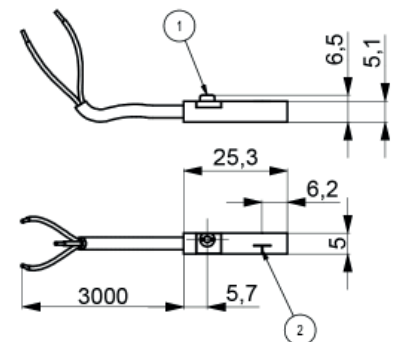
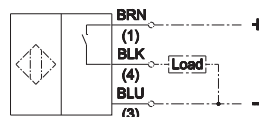
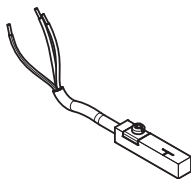

1	2	Part no.
fixing eccentric	active sensing face	DF-P700L06