

**Material:** Brass Chrome Plated  
**Working Temperature:** -20 ÷ 90 C°  
**Working Temperature:** F°  
**Working Pressure (max):** 0 ÷ 10 bar  
**Working Pressure (max):** psi  
**Vacuum:** kPa  
**Vacuum:** Hg  
**Conformity:**

**Conformity:**  
**Conformity:**  
**Conformity:**  
**Conformity:**  
**Application** Pneumatic installations fed with filtered, lubricated air

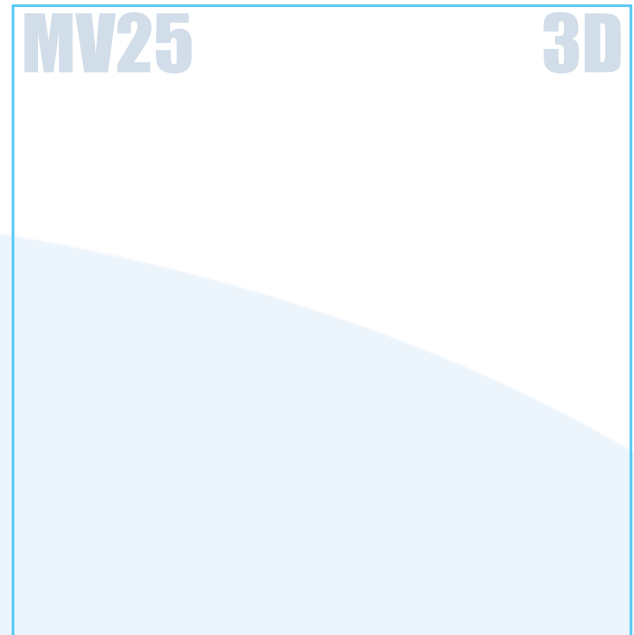
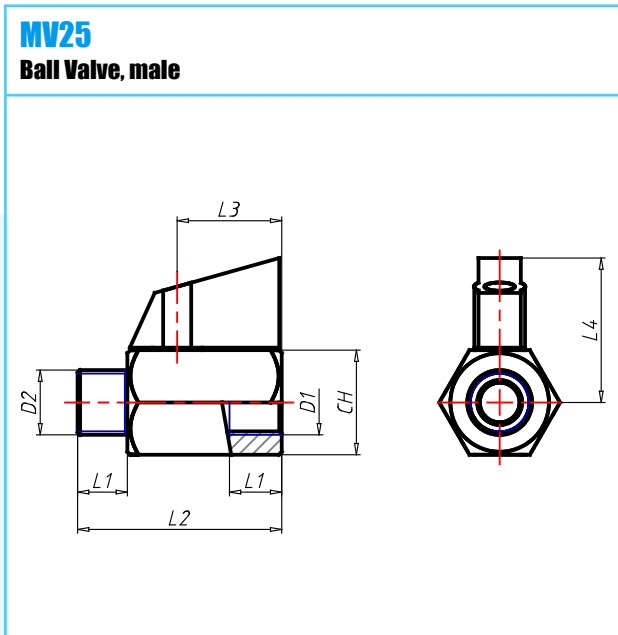

CODE	TIPO	D1	L1	L2	L3	L4	CH	G	CONF
4150001	MV25 00 18	G1/8	8.0	39	20.5	29	20	86	RoHS
4150002	MV25 00 14	G1/4	10.0	39	20.5	29	20	82	RoHS
4150003	MV25 00 38	G3/8	10.0	42	20.5	29	20	79	RoHS
4150004	MV25 00 12	G1/2	10.5	47	20.5	31	24	120	RoHS