

Stock Code	Stock Name	Plate Length	Timing-Belt	Induction Shaft	Maximum Speed
5.3.5.060080.2.1000	60x80 Roller Timing Belt Module	150 mm	5M 30	Ø10 CF53 h7	5 m/sn

Body ; 60x80 Profile (Aluminium 6063) T5
Movement Distance Per Tour ; 200 mm
Timing Pulley ; 5M-F30 Z=40
Belt Tensile Force ; 2000 N
Timing Belt Pitch ; 5 mm
Positioning Accuracy ; 0,2 mm

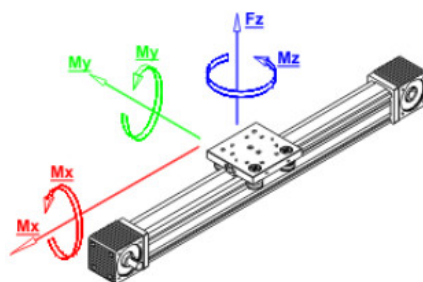
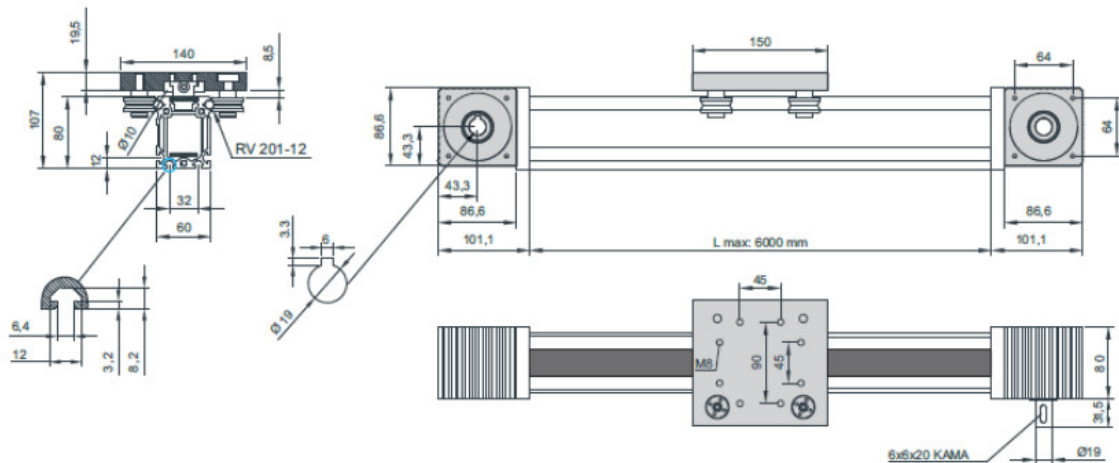

■ F_x	(N)	640
■ F_y	(N)	2030
■ F_z	(N)	1505
■ M_x	(Nm)	120
■ M_y	(Nm)	145
■ M_z	(Nm)	162