

2 WAY CONNECTOR

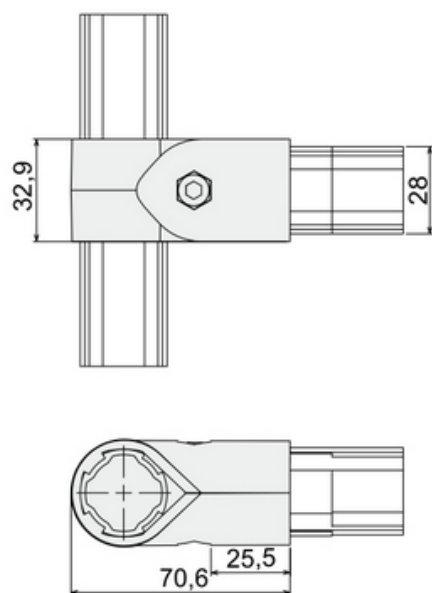

General Specifications

Stock Code	Stock Name	Product Code	Material	Weight (gr)
2.2.050.28.01.006.01	2 Way Connector	DKJ28-C01	Aluminum Casting	91