

45x90 Feet Wheel Connection Piece

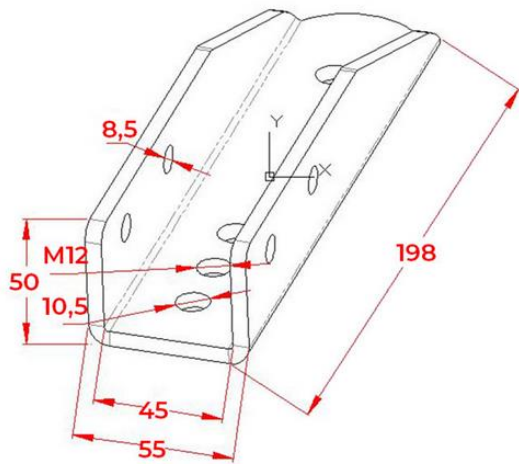

General Specifications

It is used for mounting plastic wheels and feet to 45x90 aluminum profile.

Stock Code	Stock Name	M	Material	Weight (gr)
2.2.001.045090.00.10	45x90 Feet Wheel Connection Piece	M12	HRP	885